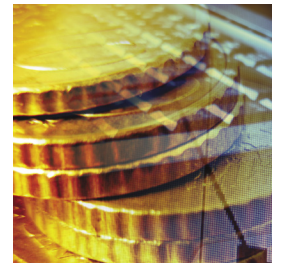




# THE POWER TO CHANGE:

## SOLAR AND WIND COST REDUCTION POTENTIAL TO 2025



## Copyright © IRENA 2016

Unless otherwise stated, this publication and material herein are the property of the International Renewable Energy Agency (IRENA) and are subject to copyright by IRENA. Material in this publication may be freely used, shared, copied, reproduced, printed and/or stored, provided that all such material is clearly attributed to IRENA and bears a notation of copyright (© IRENA) with the year of copyright. Material contained in this publication attributed to third parties may be subject to third-party copyright and separate terms of use and restrictions, including restrictions in relation to any commercial use.

This publication should be cited as: IRENA (2016), *The Power to Change: Solar and Wind Cost Reduction Potential to 2025*.

## About IRENA

The International Renewable Energy Agency (IRENA) is an intergovernmental organisation that supports countries in their transition to a sustainable energy future, and serves as the principal platform for international co-operation, a centre of excellence, and a repository of policy, technology, resource and financial knowledge on renewable energy. IRENA promotes the widespread adoption and sustainable use of all forms of renewable energy, including bioenergy, geothermal, hydropower, ocean, solar and wind energy, in the pursuit of sustainable development, energy access, energy security and low-carbon economic growth and prosperity. [www.irena.org](http://www.irena.org)

## Acknowledgements

This report was prepared by Michael Taylor (IRENA), Pablo Ralon (IRENA) and Andrei Ilas (IRENA). Special thanks are due to Dr Dolf Gielen (Director, IITC, IRENA) for his valuable feedback and guidance. IRENA is grateful for the valuable contributions of Simon Dieckmann, Jürgen Dersch, Eckhard Lüpfert, Robert Pitz-Paal and Stefano Giuliano from the German Aerospace Center (Deutsches Zentrum für Luft- und Raumfahrt: DLR) in the preparation of the concentrating solar power chapter of this study.

This report benefited from the reviews and comments of numerous experts, including Galen Barbose (Lawrence Berkeley National Laboratory), Henrik Breum (Danish Energy Agency), Bent Christensen (Siemens Wind Power), Giorgio Corbetta (WindEurope), Rob D'Angelo (exawatt), Mihaela Dragan (WindEurope), Stefan Gsänger (World Wind Energy Association), Andrew Ho (WindEurope), Greg Knight (exawatt), Sriram Krishnan (PHOTON Consulting), Gaëtan Masson (Becquerel Institute/IEA PVPS), Stefan Nowak (IEA PVPS), Ivan Pineda (WindEurope), Simon Price (exawatt), Martin Schöpe (BMW) and Ryan Wiser (Lawrence Berkeley National Laboratory).

IRENA would like to extend its gratitude to the Government of Germany for supporting this analysis.

This report is one of IRENA's deliverables to the G20 "Toolkit of Voluntary Options for Renewable Energy Deployment" that was adopted by G20 Energy Ministers in Istanbul, Turkey on 2 October 2015.

For further information or to provide feedback, please contact the costing team at IRENA's Innovation and Technology Centre (IITC), Robert-Schuman-Platz 3, D 53175 Bonn, Germany. Email: [costs@irena.org](mailto:costs@irena.org)

This report is available for download from [www.irena.org/publications](http://www.irena.org/publications).

**ISBN 978-92-95111-97-4 (PDF)**

## Disclaimer

This publication and the material herein are provided "as-is", for informational purposes.

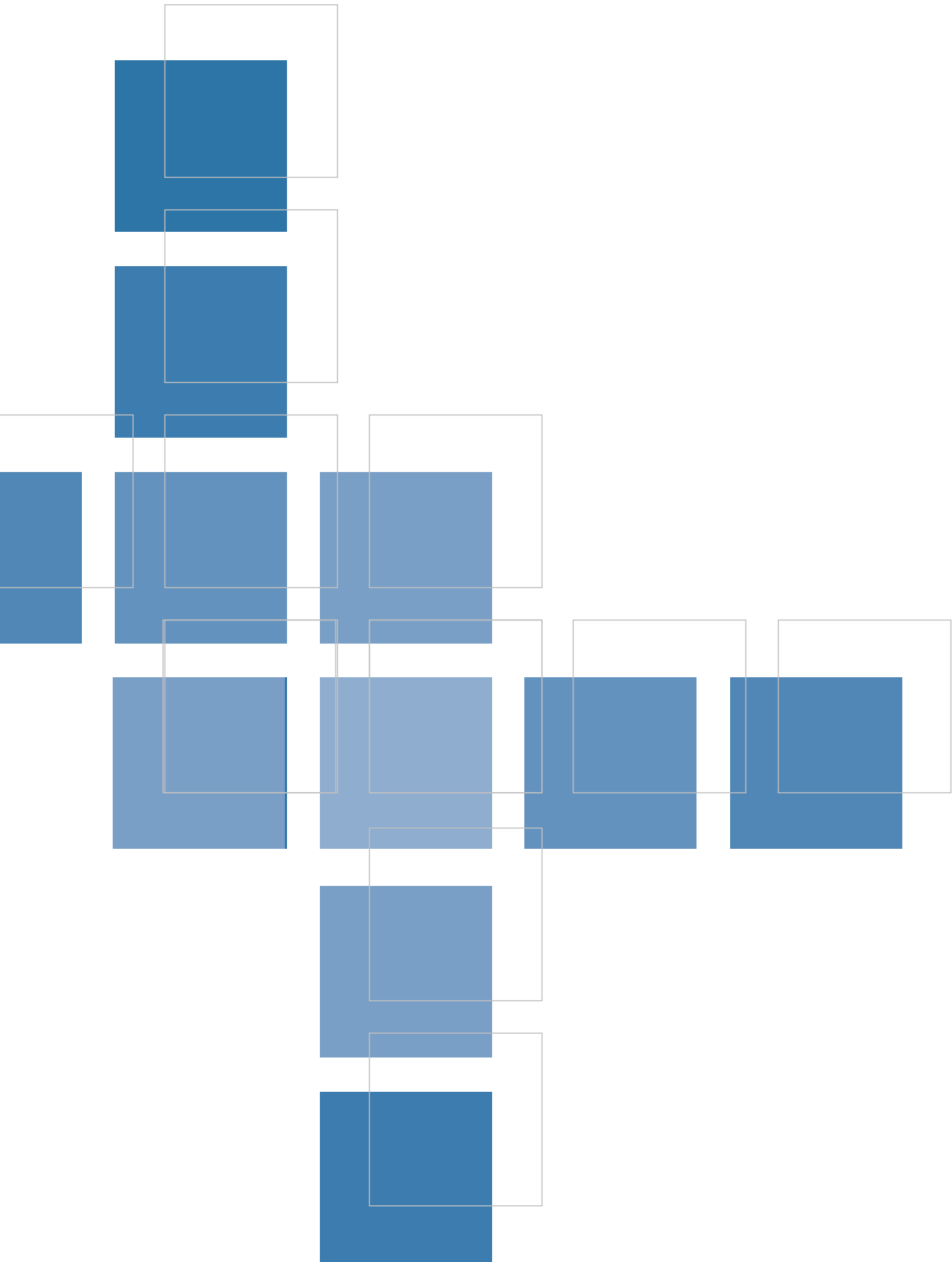
All reasonable precautions have been taken by IRENA to verify the reliability of the material featured in this publication. Neither IRENA nor any of its officials, agents, data or other, third-party content providers or licensors provides any warranty, including as to the accuracy, completeness, or fitness for a particular purpose or use of such material, or regarding the non-infringement of third-party rights, and they accept no responsibility or liability with regard to the use of this publication and the material therein.

The material contained herein does not necessarily represent the views of the Members of IRENA, nor is it an endorsement of any project, product or service provider. The designations employed and the presentation of material herein do not imply the expression of any opinion on the part of IRENA concerning the legal status of any region, country, territory, city or area, or their authorities, or concerning the delimitation of frontiers or boundaries.

# THE POWER TO CHANGE:

## SOLAR AND WIND COST REDUCTION POTENTIAL TO 2025





# FOREWORD

The age of renewable power has arrived. In every year since 2011, renewable power generation technologies have accounted for half or more of total new power generation capacity added globally. In 2015, a new record was achieved with around 148 GW of renewable power added. Support policies around the world have become increasingly effective, resulting in increased deployment, technology innovations and cost reductions, driving a virtuous cycle.



The recent Paris Climate Agreement signals a strong imperative for the world to transition to a sustainable energy future. This clear mandate to shift away from fossil fuels places renewables squarely at the forefront of the required transformation of our energy sector. The successful deployment of renewable power generation technologies around the world has highlighted that the power generation sector not only offers an opportunity to rapidly scale-up renewable power, but also decarbonise our energy sector and keep the world on track to avoid dangerous climate change.

There has been much debate about the costs and benefits of this transition. By highlighting the recent, sometimes rapid, cost reductions for solar and wind power technologies IRENA analysis has shown the solid business case for renewable power generation in an increasing number of markets.

Yet despite the increasing competitiveness of renewable power generation options today, it is a nuanced story given the wide range of installed costs in different markets. At the same time, if we are to minimise the costs of the transition to a truly sustainable energy system, further cost reductions are needed.

How large is the cost reduction potential for solar and wind power technologies in the next ten years? What are the drivers of this potential and does the policy emphasis need to change if we are to unlock these cost reductions? This new IRENA analysis seeks to anticipate the questions that go to the core of the uncertainties about how fast we can sustainably accelerate renewable power deployment.

The story of solar and wind power generation technologies is one with a difficult beginning, but the coming of age we have witnessed in the last ten years represents the beginning of the inexorable transformation of the power sector by renewables. However, we must anticipate the challenges ahead and work to remove the obstacles facing continued cost reductions for solar and wind. This new analysis by IRENA helps to plot that landscape and highlight the hard work still needed.

The analysis in this report highlights that although solar and wind power technologies are commercially mature, they are far from mature from a cost perspective. Technology innovations, increased competition, pressure on supply chains and economies of scale can all be unlocked with the right policy emphasis. Seizing this opportunity could see the cost of electricity for solar and wind power technologies fall by between a quarter and around two-thirds by 2025. The winners in this transformation will be customers, our environment and future generations.

**Adnan Z. Amin**  
Director-General  
International Renewable Energy Agency

# CONTENTS

<b>FOREWORD</b>	<b>3</b>
<b>EXECUTIVE SUMMARY</b>	<b>10</b>
• Solar photovoltaics	12
• Onshore wind	14
• Offshore wind	16
• Concentrating solar power	17
<b>1 INTRODUCTION</b>	<b>21</b>
• Purpose and objectives	21
• Cost metrics and approach to cost reduction analysis	22
• Calculating the levelised cost of electricity	24
• Cost reduction analysis to 2025	25
<b>2 SOLAR PHOTOVOLTAICS</b>	<b>29</b>
• Introduction	29
• Current technology and costs	30
• Balance of system costs	30
• Module costs	32
• Inverter costs	32
• Total installed costs	34
• Capacity factor	34
• O&M costs	35
• LCOE trends	37
• Cost reduction potential	37
• Total system costs	38
• Balance of system costs	38
• Narrowing BoS current cost differentials	42
• Module costs to 2025	42
• Inverter costs to 2025	46
• LCOE development to 2025	48
<b>3 ONSHORE WIND</b>	<b>51</b>
• Introduction	51
• Wind Power Deployment	51
• Current technology and costs	52
• Wind turbine costs	53
• Total installed costs	55
• Capacity factors	56
• Operations and maintenance costs	56
• Levelised cost of electricity	58

• Cost reduction potentials to 2025	59
• Total installed Costs	60
• Wind turbines	60
• Capacity Factors	63
• Operations and Maintenance Costs	66
• Levelised Cost of Electricity	67
<b>4 OFFSHORE WIND</b>	<b>71</b>
• Introduction	71
• Historical and current wind farm characteristics and costs	71
• Installed cost reduction potential to 2025: Technological innovation and economic drivers	75
• Construction and installation	76
• Turbine rotors, nacelles and towers	77
• Wind farm development, foundations, electrical arrays and transmission systems	79
• Improved electricity yields (capacity factors) from the same wind site	80
• Operations and maintenance costs	81
• Potential reductions in LCOE by 2025	82
<b>5 CONCENTRATING SOLAR POWER</b>	<b>87</b>
• Introduction	87
• Current technology and costs	87
• Installed costs	88
• Operations and maintenance costs	88
• Levelised cost of electricity	88
• Cost reduction potentials	91
• Installed costs	94
• Thermal storage costs	99
• LCOE development to 2025	99
<b>ABBREVIATIONS</b>	<b>103</b>
<b>REFERENCES</b>	<b>105</b>

# FIGURES

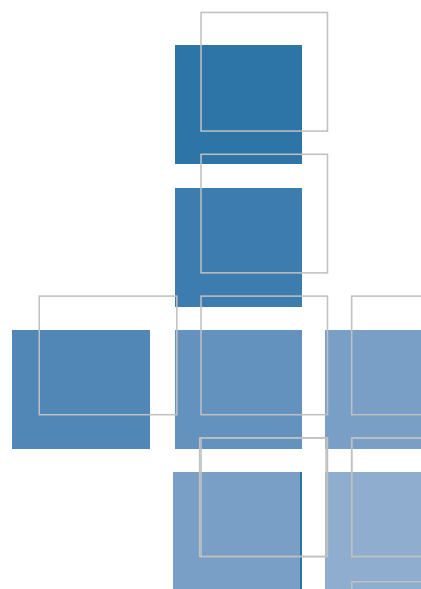
<b>FIGURE 1:</b> Cost metrics contributing to the calculation of the LCOE	23
<b>FIGURE 2:</b> Detailed breakdown of solar PV BoS costs by country, 2015	32
<b>FIGURE 3:</b> Global PV module price trends, 2009-2016	33
<b>FIGURE 4:</b> Total installed PV system cost and weighted averages for utility-scale systems, 2010-2015	34
<b>FIGURE 5:</b> Global weighted average capacity factors for utility-scale PV systems, 2010-2015	36
<b>FIGURE 6:</b> Levelised cost of electricity by project and weighted average of utility-scale solar PV systems by region, 2014 and 2015	36
<b>FIGURE 7:</b> Global weighted average total installed costs of utility-scale solar PV systems and expected cost reductions by source, 2015-2025	39
<b>FIGURE 8:</b> Historical and projected weighted average total system costs breakdown of utility-scale solar PV systems	39
<b>FIGURE 9:</b> Global weighted average utility-scale solar PV systems BoS costs and cost reductions by source, 2015-2025	40
<b>FIGURE 10:</b> Technical BoS cost reduction potential for Germany and global estimate by source, 2015-2025	43
<b>FIGURE 11:</b> Current and potential future cost ranges for crystalline modules, 2015-2025	44
<b>FIGURE 12:</b> Mono and multicrystalline silicon module cost reductions by supply chain source, 2015-2025	45
<b>FIGURE 13:</b> Share of cost reductions by economic drivers and value chain for mono and multicrystalline modules, 2015-2025	46
<b>FIGURE 14:</b> Global utility-scale solar PV LCOE range, 2010-2025	48
<b>FIGURE 15:</b> Global utility-scale solar PV LCOE by WACC, 2015-2025	49
<b>FIGURE 16:</b> Total installed cost breakdown for onshore wind projects, in Germany, 1998-2012	52
<b>FIGURE 17:</b> Wind turbine prices in the United States, China, and the BNEF wind turbine price index, 1997-2016	53
<b>FIGURE 18:</b> Onshore wind learning curve analysis data requirements	54
<b>FIGURE 19:</b> Total installed costs of onshore wind projects by country, 1983-2014	55
<b>FIGURE 20:</b> Global weighted average capacity factors for new onshore wind power capacity additions, 1983-2014	57
<b>FIGURE 21:</b> Country-specific weighted average capacity factors for new capacity, 2000 and 2014	57
<b>FIGURE 22:</b> Levelised cost of electricity for onshore wind farms by project, and weighted averages by country and region, 2014-2015	59
<b>FIGURE 23:</b> Weighted average nameplate turbine capacity by country, 1998-2014	61
<b>FIGURE 24:</b> Total installed cost reductions for onshore wind farms by source, 2015-2025	63
<b>FIGURE 25:</b> Capacity factors by IEC wind class for Nordex and Vestas wind turbines	64
<b>FIGURE 26:</b> Trends in onshore wind rotor diameter and turbine size by country, 2000-2025	65



<b>FIGURE 27:</b> Global weighted average onshore wind farm capacity factor, 1983-2025	66
<b>FIGURE 28:</b> Global weighted average onshore wind levelised cost of electricity reductions by source, 2015-2025	67
<b>FIGURE 29:</b> Levelised cost of electricity of onshore wind, 1983-2025	68
<b>FIGURE 30:</b> The sensitivity of the levelised cost of electricity of onshore wind to the cost of capital, 2015 and 2025	69
<b>FIGURE 31:</b> Offshore wind farm projects water depth and distance from port, 2001-2015	72
<b>FIGURE 32:</b> Offshore wind farm projects turbine size and overall project size, 2001-2015	72
<b>FIGURE 33:</b> Total installed costs of offshore wind farms, 2000-2015	73
<b>FIGURE 34:</b> Total installed cost breakdown for a representative offshore wind farm in European waters, 2015	74
<b>FIGURE 35:</b> Projected reductions in total installed costs for offshore wind by source, 2015-2025	75
<b>FIGURE 36:</b> Projected improvement in electricity yield at offshore wind farms for the same quality wind resource, 2015 and 2025	81
<b>FIGURE 37:</b> Operations and maintenance cost reduction potential by source, 2015-2025	83
<b>FIGURE 38:</b> Offshore wind levelised cost of electricity reduction potential, 2015-2025	83
<b>FIGURE 39:</b> Historical offshore wind LCOE by project and projections to 2025	85
<b>FIGURE 40:</b> Installed costs and capacity factors of CSP plants as a function of storage, 2007-2014	89
<b>FIGURE 41:</b> CSP levelised cost of electricity sensitivity to DNI for 2015 reference plants	90
<b>FIGURE 42:</b> Reference parabolic trough system design, 2015	91
<b>FIGURE 43:</b> Reference parabolic trough system design, 2025	92
<b>FIGURE 44:</b> Reference solar tower plant design, 2015 and 2025	93
<b>FIGURE 45:</b> Contributing factors to the LCOE of a CSP PTC system in 2015	94
<b>FIGURE 46:</b> System cost breakdown of CSP reference plants, 2015 and 2025	95
<b>FIGURE 47:</b> PTC and ST total installed cost reduction potential by source, 2015-2025	96
<b>FIGURE 48:</b> Expected indirect EPC and owner's cost reductions for CSP plants to 2025	97
<b>FIGURE 49:</b> Cost reduction potentials of the solar field component of PTC and ST CSP plants by source, 2015-2025	98
<b>FIGURE 50:</b> Thermal energy storage cost reduction potentials for PTC and ST systems by source, 2015-2025	99
<b>FIGURE 51:</b> The levelised cost of electricity of PTC and ST technologies, 2015 and 2025	100
<b>FIGURE 52:</b> Sensitivity of the levelised cost of electricity of PTC and ST plants to variations in the WACC, 2015 and 2025	101
<b>FIGURE 53:</b> The levelised cost of electricity reduction potential for PTC and ST plants by source, 2015-2025	101

## TABLES

<b>TABLE 1:</b> Balance of system cost breakdown categories for solar PV	32
<b>TABLE 2:</b> Current solar PV inverter technology characteristics and costs	34
<b>TABLE 3:</b> Trends influencing the costs of inverter technologies to 2025	48
<b>TABLE 4:</b> Expected cost reduction of inverter technologies to 2025	49
<b>TABLE 5:</b> Reported O&M costs in selected OECD countries	59
<b>TABLE 6:</b> Key design parameters of the PTC and ST reference plants, 2015	90
<b>TABLE 7:</b> Key technology variations in the reference PTC and ST plants, 2015 and 2025	93
<b>TABLE 8:</b> Total installed cost categories and their major components for PTC and ST plants	95



# EXECUTIVE SUMMARY

**While solar and wind power technologies are commercially available, they still have significant potential for cost reduction. Indeed, by 2025 the global weighted average levelised cost of electricity (LCOE) of solar photovoltaics (PV) could fall by as much as 59%,<sup>1</sup> the LCOE of concentrating solar power (CSP) could fall by up to 43%. Onshore and offshore wind could see declines of 26% and 35%, respectively.**

Previous IRENA analysis has highlighted the recent cost reduction trends for renewable power generation technologies and the historic levels of competitiveness that have been reached (IRENA, 2015).

Biomass for power, hydropower, geothermal and onshore wind can all now provide electricity competitively, compared to fossil fuel-fired power generation.

It is growth in the “new” renewable power generation technologies of solar and wind, however, that has pushed renewable power generation capacity additions to record levels. A virtuous circle of support policies driving increased deployment, technological improvements and cost reductions has seen onshore wind become one of the most competitive options for new generation capacity.

The LCOE of solar PV fell 58% between 2010-15, making it increasingly competitive at utility scale. Despite the fact that CSP and offshore wind are in their deployment infancy, these technologies are already attractive in some markets, with costs continuing to fall.

Meanwhile, COP21 saw underlined critical role of renewable energy in combatting climate change. This means deployment not only needs to continue, but continue to grow. This can be achieved against a backdrop of continued reductions in solar and wind power costs, given that although they are commercially available technologies, they still have very large cost reduction potentials.

With the right regulatory and policy frameworks, solar and wind technologies can still unlock significant additional cost reductions out to 2025 and beyond. There is significant potential for each technology to see continuous installed cost reductions and performance improvements, leading to lower LCOEs (Table 1).

**TABLE ES 1: GLOBAL WEIGHTED AVERAGE SOLAR AND WIND POWER INVESTMENT COSTS, CAPACITY FACTORS AND LCOEs, 2015 AND 2025**

	Global weighted average data								
	Investment costs (2015 USD/kW)		Percent change	Capacity factor		Percent change <sup>2</sup>	LCOE (2015 USD/kWh)		Percent change
	2015	2025		2015	2025		2015	2025	
<b>Solar PV</b>	1 810	790	-57%	18%	19%	8%	0.13	0.06	-59%
<b>CSP (PTC: parabolic trough collector)</b>	5 550	3 700	-33%	41%	45%	8.4%	0.15 -0.19	0.09 -0.12	-37%
<b>CSP (ST: solar tower)</b>	5 700	3 600	-37%	46%	49%	7.6%	0.15 -0.19	0.08 -0.11	-43%
<b>Onshore wind</b>	1 560	1 370	-12%	27%	30%	11%	0.07	0.05	-26%
<b>Offshore wind</b>	4 650	3 950	-15%	43%	45%	4%	0.18	0.12	-35%

<sup>1</sup> All financial data in this report is quoted in real, 2015 USD values, unless expressly stated otherwise. Exchange rates used are taken from the World Bank or European Central Bank official statistics. A discussion of how IRENA calculates LCOEs can be found in IRENA (2015), Renewable Power Generation Costs in 2014. IRENA assumes a real weighted average cost of capital of 7.5% in OECD countries and China and 10% elsewhere.

<sup>2</sup> Changes to 2025 reflect technological drivers and changes in the share of deployment by region for solar PV and wind.

**Cost reductions will be driven by increasing economies of scale, more competitive supply chains and technology improvements that will raise capacity factors and/or reduce installed costs. All of this will take place against a backdrop of increasing competitive pressures that will drive innovation.**

Solar and wind technologies are benefiting from support policies that have seen deployment increase steadily and, in some cases, dramatically in the last ten years. This has helped create the market conditions for the cost reductions recently experienced. It also has set the stage for solar and wind power technologies costs to continue to fall through to 2025 and beyond.

Continued technology improvements will help increase the capacity factors of onshore and offshore wind farms by improved micro-siting of turbines, improved reliability with predictive maintenance models, more efficient blades and control systems, and the deployment of turbines with higher hub heights, longer blades and larger swept areas. For concentrating solar plants, technology improvements will improve efficiencies, resulting in higher operating temperatures and lower costs for thermal energy storage. Solar PV cell architectures will continue to evolve. This will result in higher module efficiencies that reduce the area required for a given watt of power output, thereby cutting module costs.

At the same time, as global and regional markets for solar and wind power technologies grow, economies of scale are being reaped in manufacturing. With increased market scale, opportunities to improve the efficiency of supply chains arise. Individual country markets become regional, allowing greater local content, potentially reducing costs and lead-times.

**From Germany to Morocco, from Dubai to Peru and from Mexico to South Africa, intense competition in auctions and tenders focuses project developers on applying best practices. As a result, even in new markets competitive pressures are driving down costs rapidly to efficient levels ensuring solar and wind power technologies offer increasing value. The winners are customers, our environment and future generations. However, the cost reduction potential identified in this report will not happen without the right policy and regulatory frameworks in place.**

Renewable power generation costs are very site specific. Individual solar and wind power project installed cost and LCOE values cover a wide range, not only between countries, but also within. For solar PV and, to a lesser extent, onshore wind, narrowing the cost ranges by shifting to best practice cost structures represents an increasing opportunity to lower average costs.

This wide range is in part due to differences in renewable resource quality between different locations. It is also due to the wide variation in total installed costs for projects. Site-specific factors, such as the quality and availability of local infrastructure, or the distance of the project from existing transmission lines, can have an important impact on overall project development costs. Yet, there are other, non-structural, factors at work that also need to be addressed to reduce costs.

For solar PV in particular, in some markets, shifting to today's most efficient cost structures can offer much larger cost reduction potentials than technological innovation or economies of scale, relative to best practice cost levels. As an example, average residential solar PV installed costs in Germany were around 37% of those in California in Q1 2016. For utility-scale solar PV projects in 2015, Germany was estimated to have half the average installed costs of California. Some of these differences reflect structural cost differences that cannot be bridged, but analysis suggests that there are significant opportunities to reduce the gap between these extreme examples, if the right policies are put in place.

The correct policy settings will therefore be essential to unlock on going technological improvements and cost reductions. In some markets, changes to existing policy settings will also be essential in addressing

the challenging issues surrounding persistent cost premiums. In many cases, this goes significantly beyond the national level, with local municipal regulations also sometimes imposing additional costs. Similarly, governments need to be proactive in terms of setting the policy framework in such a way as to minimise transaction costs. Streamlined, yet comprehensive administrative procedures and approval processes based on pre-agreed national guidelines can help reduce project development costs and uncertainty for project developers. Much can be learned from the sharing of best practice, yet this is an area where, with some exceptions, little collaboration takes place.

**Looking forward, as equipment costs for solar and wind power continue to fall, balance of system costs,<sup>3</sup> operations and maintenance (O&M) and the cost of capital will rise in importance as cost reduction drivers.**

With the reduction in equipment costs for solar and wind power technologies, it is now common for O&M costs to account for one-fifth to one-quarter of the total LCOE. At the same time, the risk profile of the renewable power generation market and individual projects has a large impact on the cost of capital and therefore the LCOE. To avoid these two factors slowing LCOE reductions, increased policy and industry focus on driving down these costs could become increasingly important. For solar PV and, to a lesser extent, CSP and wind power, the wide variation in balance of system (BoS) costs today now often represents the largest source of cost reduction opportunities.

While industry has often already adjusted its cost reduction strategy to focus on these areas, much more detailed cost data is required than is available and systematically collected today in order to identify the potential benefits of different policy options. Without these data, analysis that can support policy makers in ensuring that policy and regulatory frameworks are streamlined and optimised will be difficult to undertake. This is particularly important, because future cost reductions in BoS costs, O&M and cost of capital will depend on a more diverse range of stakeholders, not just equipment manufacturers. Careful analysis will be needed to remove a myriad of small barriers, while policy settings must be tailored to ensure all stakeholders are incentivised and able to bring down costs.

## SOLAR PHOTOVOLTAICS

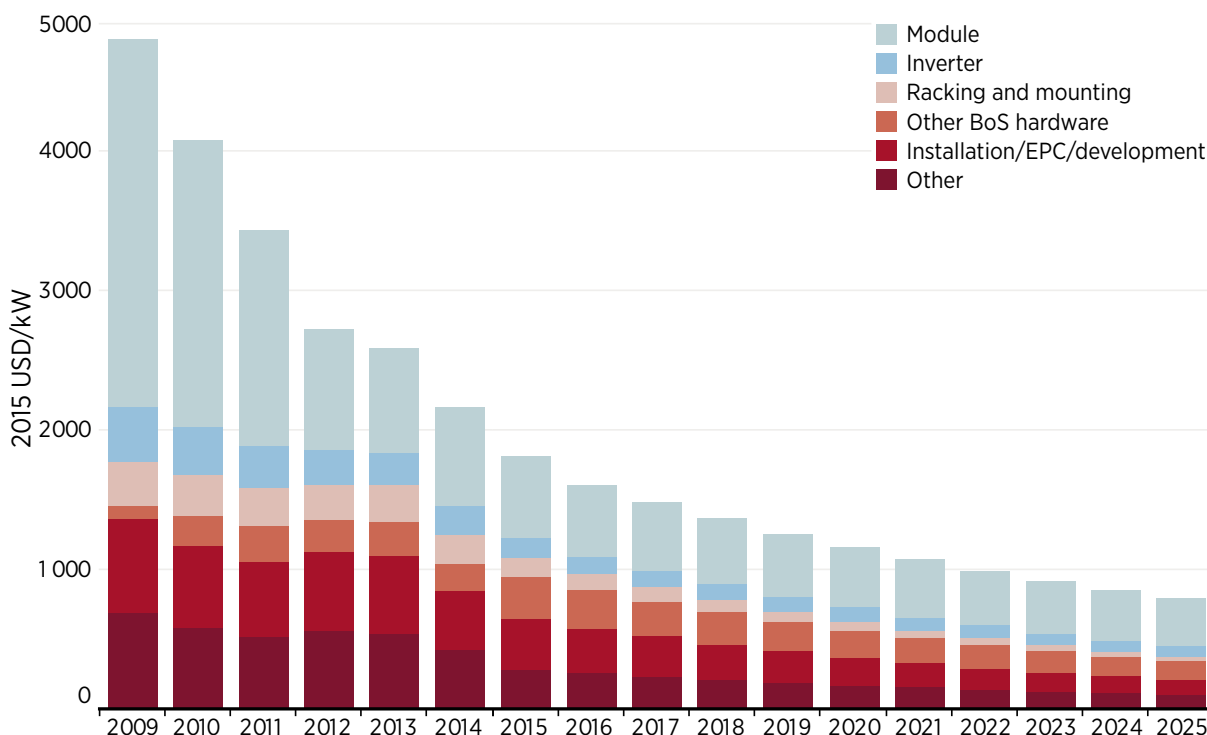
**Driven by technological improvements in solar PV modules, manufacturing advances, economies of scale and reductions in BoS costs, the global weighted-average installed costs of utility-scale PV systems could fall by 57% between 2015 and 2025. Larger cost reductions are possible if deployment accelerates and a more rapid shift to best practice BoS costs occurs.**

The global weighted average installed cost of utility-scale solar PV could fall by more than half in the next ten years, driven by continued technological improvements, competitive pressures and economies of scale, but also by convergence of BoS costs towards best practice levels. The majority (about 70%) of the cost reductions will come from lower BoS costs (Figure ES 1) reflecting the high average level of BoS costs today relative to best practice. Module costs are expected to fall by around 42% by 2025, but a narrower cost spread in different markets today means that there are no large gains from cost convergence, unlike for BoS.

A bottom-up technology-based analysis of crystalline technologies points to module costs falling to between USD 0.30 and USD 0.41/W by 2025. However, with the projected growth in solar PV deployment, learning rates suggest that module cost reductions could exceed the conventional wisdom of the industry

<sup>3</sup> This is the remaining installed cost categories, excluding the main equipment costs for each technology (e.g., modules and inverters for solar PV, wind turbines for wind power and the solar field, generating system and thermal storage systems of CSP plants).

FIGURE ES 1: GLOBAL WEIGHTED AVERAGE UTILITY-SCALE SOLAR PV TOTAL INSTALLED COSTS, 2009-2025



(with module prices falling to between USD 0.28 and USD 0.46/W by 2025). This could see a repeat of the experience between 2009 and 2013, as the solar PV industry squeezes materials costs, improves manufacturing processes and innovates towards ever higher module efficiencies at rates not anticipated today.

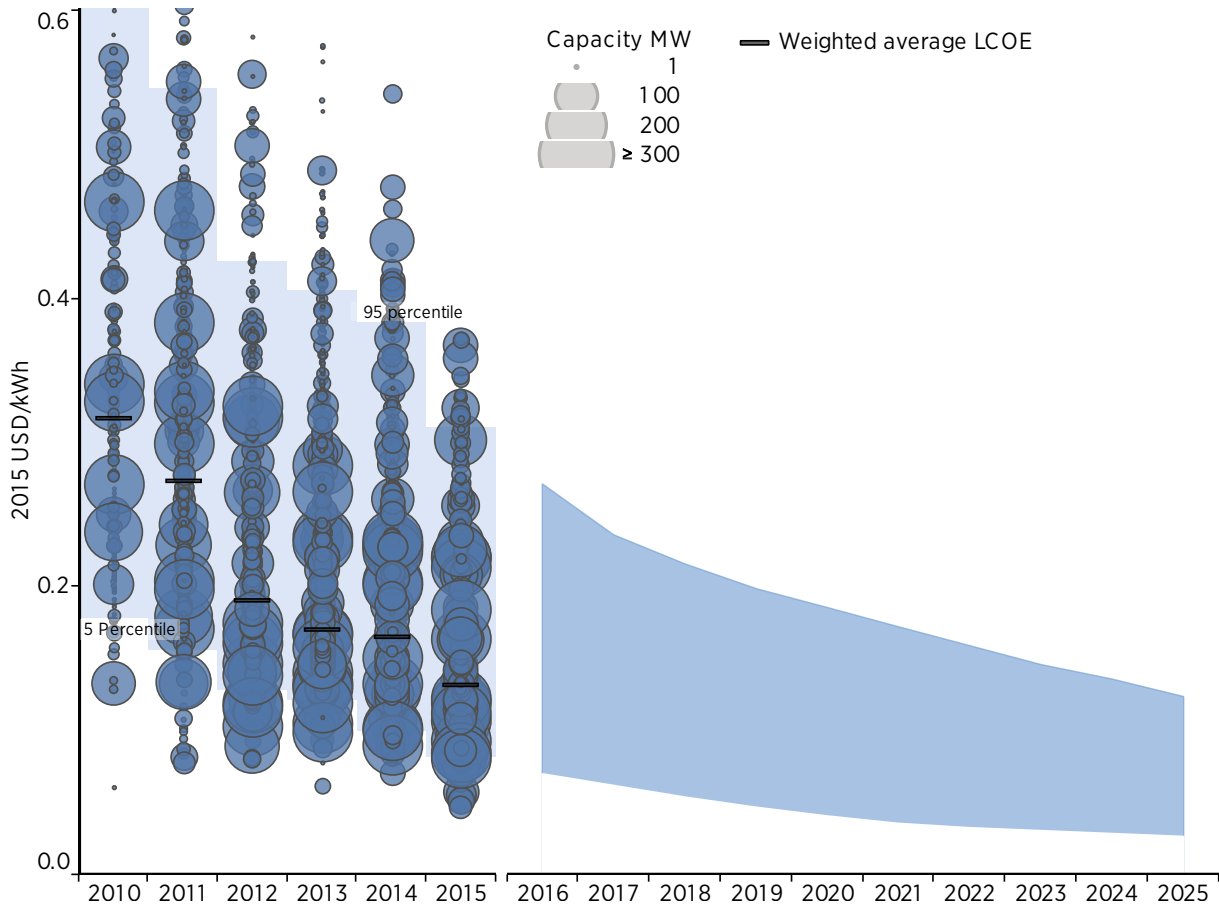
The biggest cost reduction opportunities for solar PV modules will happen at either end of the crystalline silicon module value chain. Cheaper polysilicon production will halve polysilicon costs per watt by 2025 and account for one-third of the total module cost reduction potential. This will occur along with increased reactor capacity, reduced electricity consumption and the uptake of manufacturing methods different from the classic “Siemens” process.

The next largest cost reduction potential comes from cell-to-module manufacturing. In this, the cost is expected to decline by around one-third for crystalline technologies and to contribute another third to the overall reduction potential.

Given that current country average module prices range from USD 0.52 to USD 0.72/W, absolute cost reductions from modules will be relatively modest. As a result of the high share of BoS costs today on average, globally, the bulk of the total PV system installed cost reduction potential in the next decade will come from continuous BoS cost reductions.

The central case presented above for the global weighted average installed cost assumes significant convergence towards best practice costs, as well as reductions in today’s BoS best practice costs. However, with the right policy settings, including the sharing of policy and regulatory best practices, and stable growth policies for new markets, even larger BoS cost reductions could be achieved. This could result in an additional USD 0.16/W reduction in the global weighted average total installed cost of utility-scale solar PV to USD 0.63/W in 2025 (a 65% reduction over 2015). If convergence towards best practice

FIGURE ES 2: GLOBAL UTILITY-SCALE SOLAR PV LCOE RANGES BY PROJECT, 2010-2025



Note: Circles represent individual projects in the IRENA Renewable Cost Database, the centre of the circle the value for the Y axis and the diameter of the circle the size of the project.

is slower than in the central case, then total installed costs could fall to USD 1.04/W (a 43% reduction over 2015).

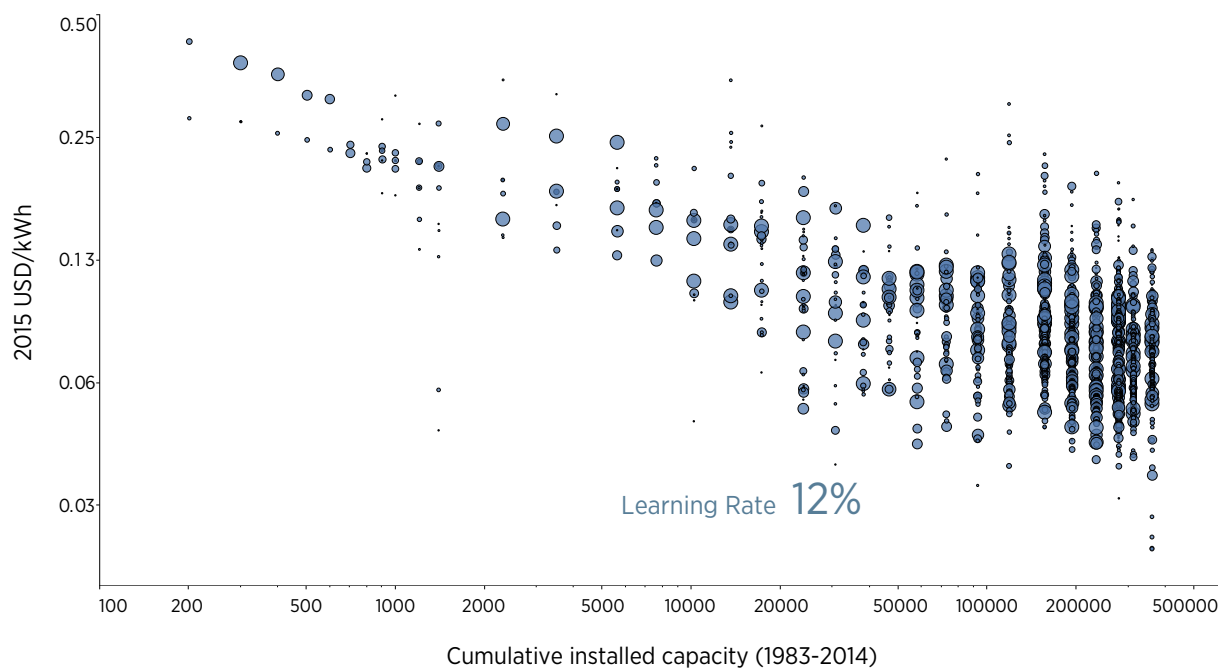
**The possible reductions in installed costs could see the LCOE of utility-scale PV projects fall by an average of 59% between 2015-2025, with project costs in the range of USD 0.03 to USD 0.12/kWh by 2025.**

Figure ES 2 shows the range of LCOE utility-scale PV projects from 2010 to 2015 (left-hand side) and the potential cost reductions in the LCOE to 2025 (right-hand side), taking into account individual project cost variations. From 2010-2015, the capacity weighted average LCOE decreased by more than half. The LCOE of utility-scale PV systems will continue to follow a downward trend and should fall slightly more than installed costs, as system losses are reduced somewhat and the global weighted average capacity factor grows with increasing deployment in regions with excellent solar resources.

By 2025, the project level cost range will narrow, as convergence in BoS costs accelerates and falls between USD 0.03 and USD 0.12/kWh. This projected LCOE range accounts for all the individual project differences from irradiation levels and capital costs in the different countries. Lower costs will be possible if longer economic lifetimes are assumed, or the weighted average cost of capital (WACC) is lower than the 7.5% assumed for OECD countries and China and 10% for the rest of the world. The ongoing announcements of



FIGURE ES 3: GLOBAL ONSHORE WIND LEARNING CURVE ANALYSIS, 1983-2014



Note: Circles represent individual projects in the IRENA Renewable Cost Database or country averages for data prior to 2000. The centre of the circle is the value for the Y axis and the diameter of the circle is the size of the project.

record low power purchase agreement and tender prices for solar PV, notably in Mexico and Dubai in 2016, highlight just how rapidly solar PV costs continue to decline.

## ONSHORE WIND

**The cost of onshore wind farms will continue to fall. Historically, the installed costs of onshore wind power have declined by 7% every time global installed capacity has doubled. By 2025, the total installed costs of onshore wind farms could decline by around 12%,**

IRENA has updated the global learning curves for onshore wind power investment costs and the LCOE for the period 1983-2014. Globally, the weighted average investment cost of onshore wind declined from USD 4 766/kW in 1983 to USD 1 623/kW in 2014, a reduction of two-thirds. This makes onshore wind a significant investment class, with cumulative investment of USD 647 billion over the period 1983 to 2014.<sup>4</sup> Preliminary data for 2015 suggest costs continued to fall, with a global weighted average of USD 1 560/kW.

Future cost reductions will come from a continuation of the current trend of increased economies of scale, as the market both grows and broadens. There will also be greater competition among suppliers in the wind power value chain. This will occur despite onshore wind turbines continuing to grow in capacity, hub height and rotor diameter, which increases electricity yields from the same wind resource, but puts upward pressure on installed costs. Innovations in advanced tower designs will help to keep tower and foundation costs from rising as fast as turbine ratings, allowing modest per-kilowatt cost reductions. Segmented blades and innovations in blade materials will help to reduce installation costs and hold down blade costs as blade

<sup>4</sup> A total of 94%, or USD 607 billion, occurred after the year 2000.

lengths grow. The more widespread application of best practice in project development can also help reduce overall project costs. Another benefit of increasing turbine capacities is that they can help reduce per-kilowatt balance of project costs (*i.e.*, costs excluding turbines) and are an important opportunity in countries with land constraints.<sup>5</sup>

Overall, turbines and towers account for the largest share of the installed cost reduction potential of USD 190/kW, accounting for 27% and 29% of the total respectively. The increased application of best practices in wind farm development by wind farm developers and regulators (*e.g.*, through streamlined project approval procedures, nationally agreed evaluation criteria for local consultation, etc.), could drive down costs further, and might account for as much as one-quarter of the total installed cost reduction potential by 2025. Supply chain and manufacturing economies of scale account for around 13% of the total cost reductions and advanced blades for the balance.

**The global weighted average LCOE of onshore wind could fall by 26% by 2025. The LCOE will fall more rapidly than investment costs, as ongoing technological improvements from improved designs, larger turbines, increased hub heights and rotor diameters unlock higher capacity factors at the same wind resource.**

Continued innovation towards larger capacity turbines, increased hub heights and rotor diameters will help improve yields for the same resource. Between 1998 and 2014 hub heights increased by 80% in Germany, 110% in Denmark and 49% in the United States. This has enabled the accessing of higher and more stable wind resources. To 2025, improved blade designs, pitch and yaw control, and more advanced towers can help unlock even higher capacity factors. Continued improvements in reliability, notably for drivetrains, will help reduce O&M costs and yield higher output by cutting outage time.

Up to 2025, the growth in these turbine characteristics and the increasing use of turbines optimised for low-wind speed sites will see continued gains in capacity factors for most markets. Some markets may see these gains reduced or offset, however, as the average quality of wind sites available for development declines. Overall, though, there remains strong potential for capacity factors to rise. The global weighted average capacity factor for new wind turbine developments could increase by about five percentage points, from 27% in 2014 to 32% in 2025. Additionally, some reductions in O&M costs for wind farms will also help drive down the LCOE of onshore wind.

The combination of lower total installed and O&M costs, as well as rising capacity factors, means the LCOE of onshore wind could fall by 26% by 2025, more than twice that of the anticipated decline in installed costs. Improvements in capacity factors would account for just under half of this potential, despite the fact that in some more mature markets, wind farms have already accessed most of the best sites.<sup>6</sup> Installed cost reductions comprise around 34% of the reduction and reduced O&M costs the remainder.

## OFFSHORE WIND

**The total installed cost reduction potential for offshore wind is in the region of 15% by 2025, with most of the potential coming from lower installation costs. This will be unlocked by larger turbines, more efficient processes, increased on-land pre-assembly and commissioning of components, and more rapid foundation installation.**

<sup>5</sup> Similarly, the shift to higher hub heights allows wind projects to access otherwise unsuitable land that due to surrounding features disrupts the air flow at lower heights (*e.g.*, forested areas).

<sup>6</sup> Beyond 2025, re-powering of existing sites, as current turbines reach the end of their operational life, will represent another driver for capacity factor growth.

Offshore wind is in its infancy compared to onshore wind, with total installed capacity having reached 12 GW at the end of 2015. Between 2000 and 2015, the LCOE of offshore wind rose as capital costs increased. This was because projects moved further offshore and from ports, and into deeper waters. The increase was mitigated by larger turbines, larger swept areas and the focus on sites with better wind resources yielding increased capacity factors.

Installed costs appear to have peaked, and there are incremental opportunities to reduce total installed costs across the entire offshore wind farm value chain by 2025. The largest opportunity lies in the construction and installation process, which could account for over 60% of the total installed cost reduction potential out to 2025. Also making a contribution are incremental cost reductions for turbine rotors and nacelles, as well as towers. There is an economic trade-off between the large 6 MW+ turbines that will yield higher capacity factors as they erode some of the technology innovation cost benefits in blades (larger turbines require longer blades), support structures and towers. However, the net benefits from this approach are significant for the overall LCOE of the project.

**By 2025, the LCOE of offshore wind farms could fall by 35%. As a result of the deployment of the next generation of advanced, large offshore wind turbines. Future wind farms will have higher capacity factors, while being developed in a larger industry better understood by financiers. LCOE declines will also be driven by the reduced costs for installation and construction, and from more efficient project development practices.**

A continued focus on achieving cost reductions through optimising wind farm design and components, as well as opportunities to reduce O&M costs, could unlock average future LCOE reductions of around 35% by 2025. Given uncertainty around the various factors contributing to installed cost reductions, capacity factor increases and O&M improvements, the range is estimated to be between 32% and 42% for equivalent individual projects.

The largest component of the reduction in the LCOE will come from a reduced (WACC). This will occur as a larger pool of experienced developers emerges with greater experience in increasingly mature local and regional markets. There will also be a wider appreciation by a larger group of financial institutions of the actual risks posed by offshore wind projects.

The next largest source of LCOE reduction will come from developments around the turbine, especially the shift from large 6 MW turbines to very large (8 MW+) turbines. It will also come from blade and drivetrain improvements. These developments will lead to increased capacity factors, lower downtime and lower O&M costs.

## CONCENTRATING SOLAR POWER

**The total installed costs for CSP plants could fall by between 33% and 37% by 2025. These reductions will be driven by technology improvements in the solar field elements, reduced component and engineering costs, learning effects from larger deployment volumes and greater industry experience.**

CSP refers to a group of technologies, with parabolic trough collector (PTC) and solar towers (ST) the dominant commercial technologies. By 2025, a reference PTC plant with 7.5 hours storage could see total installed costs decline by 33%, from USD 5 550/kW in 2015 to USD 3 700/kW.<sup>7</sup> Cost reductions for the solar field component (mirrors, collectors, piping, etc.) will contribute about one-third to the total installed cost reduction potential. Other important cost reductions will come from learning effects, significant expected

<sup>7</sup> This is for a reference plant with 7.5 hours storage, with the solar irradiation level of the Moroccan Noor CSP plants.

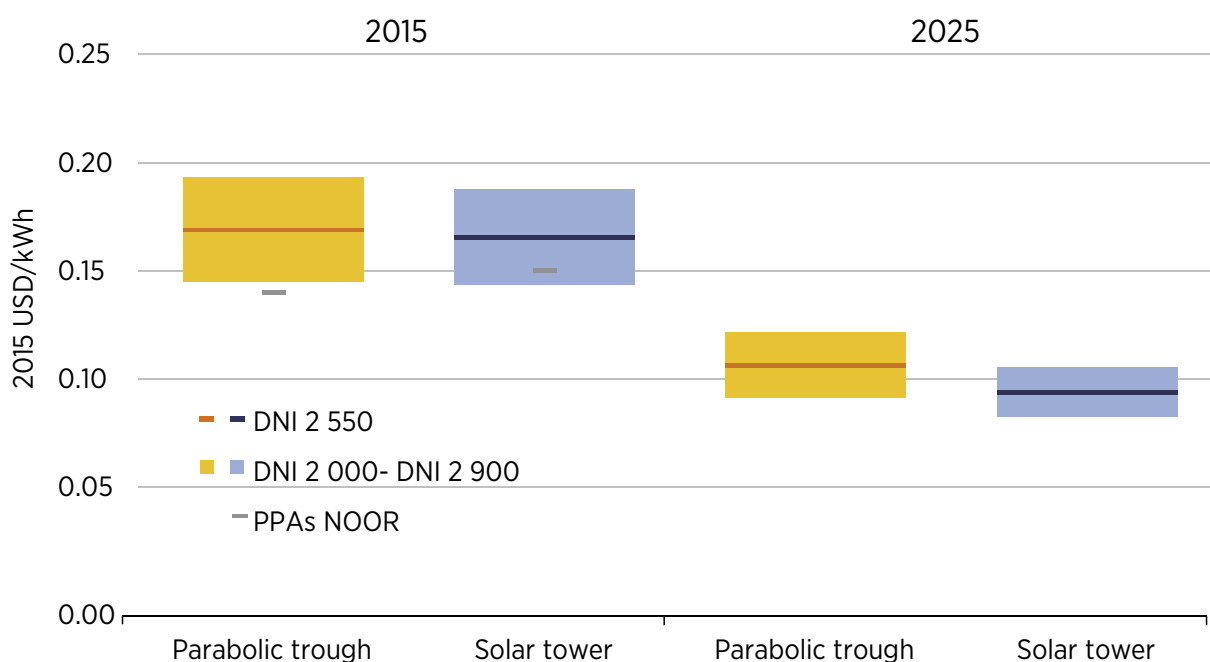
declines in the indirect costs for engineering and management, and in the owner's costs elements. Risk margins of suppliers and EPC contractors are expected to decrease along with increased commercial deployment of the technology. Indirect engineering and owner's costs together are expected to contribute close to half of the total installed cost reduction potential of PTC systems out to 2025. Over the same period, thermal energy storage system cost reductions will account for about one-fifth of the installed cost reduction potential. At the same time, the overall efficiency of PTC plants is expected to increase from 15% to 17% by 2025.

For a reference ST plant with nine hours of storage, the total installed costs could decrease from USD 5 700/kW in 2015 to USD 3 600/kW in 2025 – a 37% reduction. This will be driven by reductions in the engineering, procurement and construction (EPC) and owner's cost categories. Together, these two categories will contribute more than half of the expected total cost reduction, while cost reductions in the solar field (called heliostats in ST) are expected to account for about one-quarter of the overall reduction potential. Solar tower technologies have a shorter track record than PTC systems. This meant many project developers' first commercial plants incurred relatively high costs for contingencies and additional surcharges, as is typical of early technological development. Reducing these cost premiums as deployment grows explains the slightly higher cost reduction potential for ST technologies.

**By 2025, the LCOE of CSP technologies could decrease by about 37% for PTC plants and by about 44% for ST. Around 60% of this decrease will be driven by lower installed costs.**

CSP deployment has recently passed 5 GW, and scaling up the industry and accelerating deployment will drive cost reductions for CSP. LCOE reductions out to 2025 will be mostly driven by capital cost reductions, notably for the solar field and thermal energy storage systems, but also by incremental performance improvements. These will come as higher operating temperatures for PTC plants are unlocked by a transition from synthetic oils as a heat transfer fluid to molten salts. This will not only improve the efficiency of the

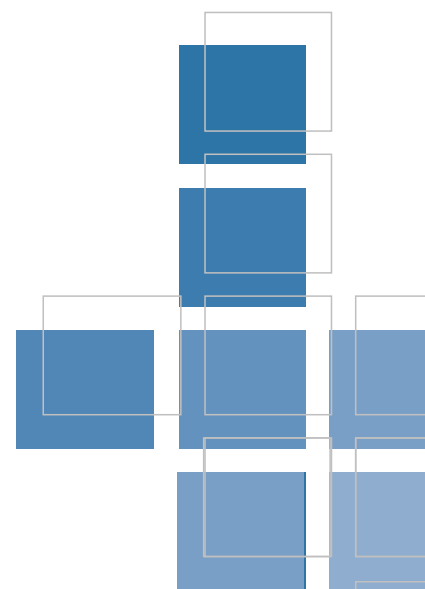
**FIGURE ES 4: THE LEVELISED COST OF ELECTRICITY OF PARABOLIC TROUGH AND SOLAR TOWER TECHNOLOGIES, 2015 AND 2025**

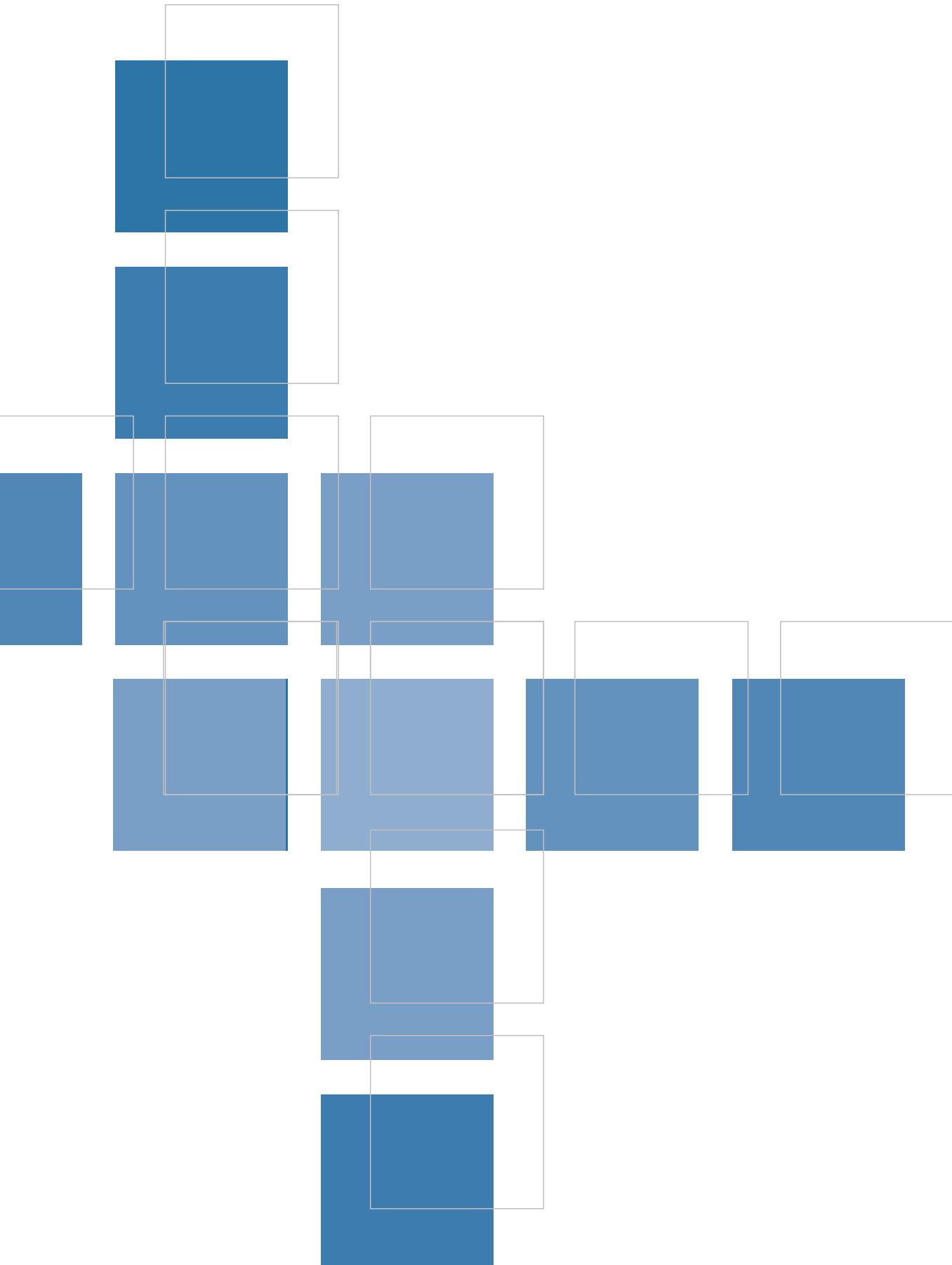


Note: The LCOE for the direct normal irradiance (DNI) 2 550 calculated at 7.5% WACC is represented by a thick line across the centre of the shaded region on the chart. The lighter shaded area represents more varied assumptions about resource quality (DNI). For reference, the power purchase agreement prices from the NOOR II and NOOR III projects are also displayed.

power block, but also reduce the installed costs of the thermal energy storage system by 40%, as a result of a halving in the required storage volume.

ST plants, with their ability to operate at higher temperatures than parabolic trough systems, have the potential to surpass parabolic troughs as the most competitive CSP option by 2025. By then, PTC plants could average USD 0.11/kWh for the reference plant, with STs achieving costs of USD 0.09/kWh. Lower costs are possible in higher solar irradiation sites than for the reference plant (e.g., in Chile and South Africa), or when financing costs are lower than the 7.5% WACC assumed. This has certainly been the case for the Moroccan “Noor” projects, thanks to help from multilateral lending and development finance institutions.





# 1 INTRODUCTION

Renewable energy technologies can help countries meet their policy goals for secure, reliable and affordable energy; electricity access for all; reduced price volatility; and the promotion of social and economic development. Recent and expected cost reductions in renewable power generation technologies clearly show that renewables are now an increasingly cost-effective solution to achieve these goals. This is particularly important given the agreement in Paris in 2015 at COP21, as it gives confidence that the costs of the transition to a sustainable energy future can be managed and are declining. The virtuous cycle of policy support for renewable power generation technologies leading to accelerated deployment, technology improvements and cost reductions has already had a profound effect on the power generation sector. It is also setting the basis for what could one day be the complete transformation of the energy sector by renewable energy technologies.

The rising deployment of renewable energy increases the scale and competitiveness of the markets for renewable technologies, and with every doubling in cumulative capacity of a renewable technology, costs can come down by as much as 18% to 22% for solar photovoltaic (PV) modules and 12% for wind. The result is striking: renewable energy technology equipment costs are falling and the technologies themselves are becoming more efficient. The combination of these two factors is leading to declines, sometimes rapid ones, in the cost of energy from renewable technologies. To date, this transformation is most visible in the power generation sector, where dramatic cost reductions for solar PV and, to a lesser extent, for wind power, are driving high levels of investment in renewables.

In the past, deployment of renewables was hampered by a number of barriers, including their high upfront costs. Today's renewable power generation technologies are increasingly cost-competitive and are now the most economical

option for any electricity system reliant on oil products (e.g., some countries and for off-grid electrification). In locations with good resources, they are the best option for centralised grid supply and extension. Yet, the public debate around renewable energy often continues to suffer from an outdated perception that renewable energy is not competitive.

## PURPOSE AND OBJECTIVES

For a transition to a truly sustainable energy sector to be achieved at least cost, continued technology improvements and cost reductions from the less mature renewable power generation technologies need to be sustained. Wind power, both onshore and offshore, concentrating solar power (CSP) and solar PV are all commercially available technologies with significant cost reduction opportunities.<sup>1</sup> This report briefly discusses the historical trends in their deployment and technology evolution and examines in detail the latest cost and performance data for 2015 from the IRENA Renewable Cost Database and other sources. It then looks at the cost reduction potential for these technologies up to 2025. In doing so the report highlights another emerging issue. This is, that due to the recent rapid cost declines seen for solar PV modules and, to a lesser extent, wind turbines, the absolute cost reduction opportunities in the future will increasingly need to come from three sources: balance of system (BoS) costs (sometimes referred to as balance of project), operations and maintenance cost optimisation, and reduced financing costs. This in turn focuses the spotlight on today's significant variation in costs, both between countries and within countries for an individual technology. Unlocking these cost reduction potentials, that depend less on equipment costs,

<sup>1</sup> *Hydropower and most biomass combustion and conventional geothermal technologies are mature, and their cost reduction potentials are not as large.*

will require a shift in policy focus and may also be more difficult to achieve. Addressing the issues required to achieve efficient cost structures and the myriad of players involved in the balance of project costs (e.g., from civil works to permitting) means addressing a wide range of smaller stakeholders working in fragmented and disparate markets, rather than major equipment manufacturers and project developers operating at scale.

The aims of this report are to:

- » Provide up-to-date, verified data on the range of costs and performance of solar PV, CSP and onshore and offshore wind power generation technologies, as well as recent technology trends.
- » Provide up-to-date, transparent projections of the cost reduction potentials of solar PV, CSP and onshore and offshore wind power generation technologies to 2025 and detail information on the drivers for this reduction potential.
- » Ensure that decision makers in government and the energy industry have the latest data about the expected cost reduction potential of these technologies to support their decisions, policy making and regulatory setting.
- » Provide powerful messages about the continued declining costs of these renewable energy technologies and their increasing competitiveness.

## **COST METRICS AND APPROACH TO COST REDUCTION ANALYSIS**

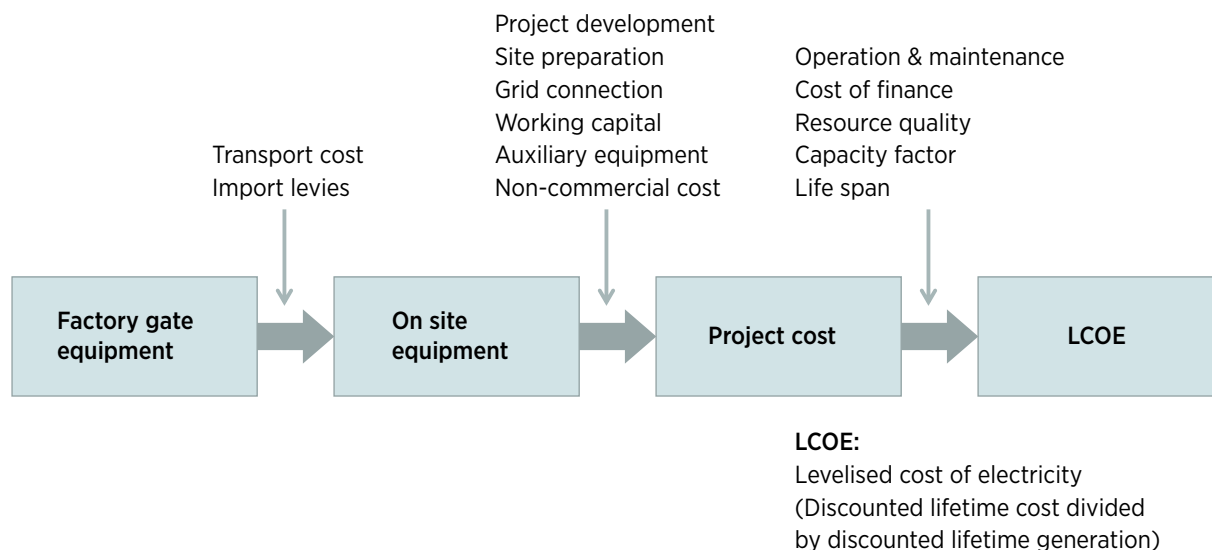
The starting point for the analysis presented in this report is the IRENA Renewable Cost Database. This contains information on the installed costs, capacity factors and LCOE of 15 000 utility-scale renewable power generation projects around the world. It is also supplemented by secondary sources, where data gaps exist.

There are a number of important points to remember when interpreting the data presented in this report:

- » The analysis is for utility-scale projects only (>1 MW for solar PV, >5 MW for onshore wind, >50 MW for CSP and >200 MW for offshore wind). Projects below these size levels may have higher costs than those quoted in this report.
- » All cost data in this report refer to the year in which the project is commissioned.
- » All data are in real 2015 USD, that is to say corrected for inflation.
- » When average data are presented, they are weighted averages based on capacity.
- » Data for costs and performance for 2015 are preliminary for solar PV and onshore wind. Some revisions are likely as additional data are reported.
- » Cost data in this report exclude any financial support by governments (national or sub-national) to support the deployment of renewables or to correct the non-priced externalities of fossil fuels.
- » The impact of grid constraints and curtailment is not accounted for in this analysis. This is a market issue beyond the scope of this report.
- » The weighted average cost of capital (WACC) is fixed over the period 2015-25 for the more mature solar PV and onshore wind technologies, but an estimate of reduced WACC is included for CSP and offshore wind as deployment for these technologies grows.
- » The LCOE of solar and wind power technologies is strongly influenced by resource quality; higher LCOEs don't necessarily mean inefficient capital cost structures.
- » Different cost metrics yield different insights, but in isolation don't necessarily provide sufficient information to assess whether or not costs in different markets are at "efficient" cost levels.



FIGURE 1: COST METRICS CONTRIBUTING TO THE CALCULATION OF THE LCOE



- » Publicly available data for power purchase agreements (PPAs), feed-in tariffs (FITs), tenders and auctions are not necessarily directly comparable between each other or with LCOEs calculated in this report. Care must be taken in interpreting these values.
- » Learning curve analysis utilises the renewable power technology capacity projections found in IRENA's REmap 2030 analysis of the doubling of the share of renewables in the total energy mix (IRENA, 2016a).

The cost of power generation technologies can be measured in a number of ways, and each way of accounting for the cost brings its own insights.<sup>2</sup> IRENA's analysis for this report focuses on analysing the impacts of technology and market developments on the LCOE. To understand the drivers of these changes requires an analysis of the equipment costs, total installed costs, performance (capacity factors), operation and maintenance (O&M) costs and WACC (Figure 1). The LCOE is an indicator of the price of electricity required for a project where revenues would equal costs, including making a return on the capital invested equal to the discount rate. An electricity price above this would yield a greater return on capital, while a price below it would yield a lower return on capital, or even a loss.

<sup>2</sup> See IRENA, 2015 for a more detailed discussion of the IRENA LCOE methodology and the underlying assumptions used.

The analysis here is designed to inform policy makers and decision makers about the trends in the relative costs and competitiveness of renewables out to 2025. It therefore excludes the impact of government incentives or financial support for renewables. The analysis also excludes any system balancing costs or benefits associated with variable renewables, and any system-wide cost savings from the merit order effect. Furthermore, the analysis does not take into account any CO<sub>2</sub> pricing or the benefits of renewables in reducing other externalities, such as reduced local air pollution or contamination of the natural environment. Similarly, the benefits of renewables being insulated from volatile fossil fuel prices have not been quantified. These issues are important, but are covered by other programmes of work at IRENA.

In assessing the cost reduction potential, IRENA has focussed on the core drivers of the LCOE (Figure 1) and how these could change over time as technology improves and matures, and markets both grow and broaden.

Clear definitions of the categories of technology are provided, where this is relevant, to ensure that cost comparisons are robust and provide useful insights. Similarly, it is important to differentiate between the functionality and/or qualities of the renewable power generation technologies to aid in direct cost comparisons or understand some of the reasons driving cost differentials (e.g., concentrating solar

power with and without thermal energy storage). It is important to ensure that system boundaries for costs are clearly set and that the available data are directly comparable.

## Calculating the levelised cost of electricity

The LCOE of renewable energy technologies varies by technology, country and project, based on the renewable energy resource, capital and operating costs, and the efficiency/performance of the technology.

The approach used to assess the LCOE in this report is based on a simple discounted cash flow analysis. This method of calculating the cost of electricity is based on discounting financial flows (annual, quarterly or monthly) to a common basis, taking into consideration the time value of money. Given the capital-intensive nature of most renewable power generation technologies and the fact that fuel costs are low-to-zero, the WACC (or discount rate) used to evaluate the project has a critical impact on the LCOE.

The formula used for calculating the LCOE in this report is:

$$\text{LCOE} = \frac{\sum_{t=1}^n \frac{I_t + M_t + F_t}{(1+r)^t}}{\sum_{t=1}^n \frac{E_t}{(1+r)^t}}$$

Where:

LCOE = the average lifetime levelised cost of electricity generation;

$I_t$  = investment expenditures in the year  $t$ ;

$M_t$  = operations and maintenance expenditures in the year  $t$ ;

$F_t$  = fuel expenditures in the year  $t$ ;

$E_t$  = electricity generation in the year  $t$ ;

$r$  = discount rate; and

$n$  = life of the system.

As already mentioned, different cost measures provide different useful information. Different cost measures therefore need to be considered in the context of what question is being asked.

For instance, comparing the installed cost of an individual technology across different markets can highlight cost differentials, but not identify their cause. Higher costs in one market don't necessarily imply cost "inefficiency", but may be due to structural factors, such as greater distances to transmission networks, higher materials and labour costs. Only a detailed country-specific analysis, supported by very detailed cost breakdowns, can hope to provide answers to these questions.

Similarly, although the LCOE is a useful metric for a first-order comparison of the competitiveness of projects, it is a static indicator of cost that doesn't take into account interactions between generators in the market. Nor does it take into account that the profile of generation of a technology may mean that its value is higher or lower than the market average. As an example, CSP with thermal energy storage has the flexibility to target output in high cost periods of the electricity market, irrespective of whether the sun is shining. The LCOE also doesn't take into account other potential sources of revenue or costs. For example, hydropower can earn significant revenue in some markets from providing ancillary grid services. This is not typically the case for stand-alone variable renewable technologies, but improved technology for solar and wind technologies are making them more grid friendly. Hybrid power plants, with storage or other renewable power generation technologies, and the creation of "virtual" power plants that mix generating technologies can transform the nature of variable renewable technologies to more stable and predictable generators.

A static analysis of LCOEs of different power generation technologies alone cannot identify the optimal role of each renewable power generation technology in a country's energy mix. Yet, the cost metrics provided in this report represent the building blocks for the dynamic modelling of the electricity system that can take into account all the specificities of demand and the network, as well as the existing generators' costs. This report provides a robust dataset that includes current, as well as future, costs of solar and wind power technologies that can be used in dynamic energy sector models to ensure that the many complexities of operating an electricity grid are

## BOX 1

### The weighted average cost of capital

The analysis in this report assumes a WACC for a project of 7.5% (real) in Organisation for Economic Co-operation and Development (OECD) countries and China. Borrowing costs are relatively low in these countries, while stable regulatory and economic policies tend to reduce the perceived risk of renewable energy projects. For the rest of the world, a WACC of 10% is assumed. These assumptions are average values, but the reality is that the cost of debt and the required return on equity, as well as the ratio of debt to equity, varies between individual projects and countries. This can have a significant impact on the average cost of capital and the LCOE of renewable power projects. It also highlights that ensuring that policy and regulatory settings minimise perceived risks for renewable power generation projects can be a very efficient way to reduce the LCOE by lowering the WACC.

The analysis in this report focuses on the technology and market drivers of cost reduction in terms of improved performance and lower installed costs, as well as O&M costs. By assuming a fixed cost of capital for the period to 2025, except for offshore wind and CSP, trends in the performance of individual technologies and installed costs translate cleanly into impacts on the LCOE.

Analysing the potential impact of the growing maturity of different markets for different technologies in order to determine potential reductions in risk premiums by country is beyond the scope of this report. This type of analysis can provide an indication of changes in costs, but is complicated by the fact that reliable data on the costs of debt and equity in different markets for different technologies over time are simply not available today. Hence, any analysis would not be grounded in real project data. For CSP and offshore wind, which are in their commercial infancy, an indicator of the possible impact of a reduced cost of capital is included as the technology risk premium declines and the technology is better understood by financial institutions. Solar PV and onshore wind are much more mature and financial institutions are more experienced in their development. However, in new markets for these technologies, it may take time for local financial institutions to be able to properly assess the real risks facing solar PV and onshore wind, meaning cost of capital premiums over more mature markets may exist and persist for a number of years until experience is gained by local developers and financing institutions. It is worth noting that the increased presence of international developers in new markets is limiting or even eliminating the premium sometimes experienced in new markets.

adequately assessed in determining the potential future role of renewables.

This report compares the cost and performance of solar and wind power technologies by taking a range of simple metrics. It looks at these using a consistent boundary in order to ensure robust analysis, comparability of the data and the possibility of conveying clear messages about the trends in solar and wind power technology costs. The report provides insights into current costs and their differentials, technology trends and their potential impact on the costs and performance of solar and wind power technologies out to 2025. It has important implications for policy makers as we shift into an era where renewables are increasingly the most competitive option for new power generation capacity. This era, however,

is also one in which the rate of transformation lags behind what is required if a truly sustainable energy system is to be achieved in a timely manner, avoiding dangerous climate change.

### Cost reduction analysis to 2025

Using the current cost data from the IRENA Renewable Cost Database as a starting point, the general approach in this report is to provide alternative views of the evolution of the costs and performance of solar and wind power technologies to 2025. The analysis is based on two different, but complimentary approaches: a top-down learning curve analysis, and a bottom-up analysis of the technological drivers (e.g., PV cell architectures and manufacturing processes) and their impact on

cost and performance (e.g., higher capacity factors from larger swept rotor areas of wind turbines). In both instances, the analysis takes into account market developments that will impact costs (e.g., more efficient supply chains, increased share of state-of-the-art technologies, greater market maturity, etc.). These two approaches provide different evolutionary views. The learning curve analysis helps highlight if a detailed bottom-up analysis is consistent with long-term trends, given that there is a risk that bottom-up analyses may suffer from a myopic technology assessment or fail to integrate unpredictable technology trends. Neither approach is “correct” or can be considered to be more authoritative, but they inform each other and provide a better overall view of possible cost reduction potential.

The analysis is focussed on the core drivers of the LCOE and how these could change over time, as technology improves and matures, markets grow and deployment broadens. By identifying the technology and cost implications for each factor contributing to the LCOE posed by the evolving technological landscape for solar and wind, a detailed bottom-up vision of the overall cost reduction potential can be derived. This detail allows greater scrutiny of the underlying contribution of different factors and assumptions to overall LCOE projections. It also facilitates the comparison of costs by country or region for the same technologies, helping identify the main causes in any differences.

For solar PV, IRENA worked with consultants to identify the underlying trends in today’s best technologies for module and inverter manufacturing and BoS components.<sup>3</sup> For modules, a detailed bottom-up analysis of current state-of-the-art module manufacturing was conducted from polysilicon production to finished module, examining material inputs and price trends, the evolution in manufacturing techniques and processes, and the use of different

<sup>3</sup> IRENA worked with CREARA Consultores, S.L. and Deea Solutions, GmbH to analyse the current and future trends for modules and inverters, and solar PV BoS costs, respectively. IRENA also reviewed the available literature from academics, research institutions and industry. The analysis for all technologies also benefitted from the inputs of the participants in the IRENA workshop “The Future of Competitiveness: Cost Reduction Potentials for Solar and Wind” held on 23 March 2015.

cell architectures and innovations in modules.<sup>4</sup> The market for inverters is evolving as trends in utility-scale solar farm design evolve, with the report examining technology trends in both string and central inverters. For BoS costs for utility-scale solar PV, IRENA examined detailed current BoS cost breakdowns in five countries and slightly coarser BoS cost breakdowns for 10 major markets. This was in addition to BoS totals for all major markets, as well as data on cost breakdowns from secondary sources when available. Given the wide range in BoS cost structures in different markets, analysis was conducted to identify “best-in-class” BoS cost structures for each of the different market groupings (resolved into high-, medium- and low-cost BoS markets). Analysis of the potential for further cost reductions to 2025 in BoS from best-in-class levels was also conducted, looking at the impact of improved module efficiency, installation techniques, wiring and cabling, and other factors. Scenarios for convergence in BoS costs to the lowest level were then explored in order to identify the sensitivity of the results to different convergence scenarios.<sup>5</sup> It is important to note that the conditions for each scenario of convergence are not driven by technology factors, but predominantly by market and regulatory considerations.<sup>6</sup>

The analysis for CSP was conducted in cooperation with the German Aerospace Center (Deutsches Zentrum für Luft- und Raumfahrt: DLR). To identify cost reduction opportunities out to 2025, DLR conducted detailed cost and performance modelling for a reference parabolic trough collectors (PTC) and solar towers (ST) plant in 2015 and 2025. This took into account the technologies likely to be commercialised by 2025, improvements in performance from technological innovation and process integration, as well as

<sup>4</sup> A version of the module cost model is available online at [www.irena.org/costs](http://www.irena.org/costs). This allows users to manipulate some of the underlying assumptions in order to see the sensitivity of the results to variations in these inputs.

<sup>5</sup> BoS cost breakdowns for 10 countries and additional supporting material is available online at [www.irena.org/costs](http://www.irena.org/costs).

<sup>6</sup> This is an oversimplification of the process, as individual market maturity will also affect cost structures. However, IRENA hasn’t attempted to identify the rate of growth of new markets out to 2025 or their potential starting cost structure. The uncertainties involved in this kind of scenario analysis would require additional sensitivity analyses that would greatly expand the range of uncertainty, reducing the value of such an exercise.

cost reduction potentials for individual CSP plant components.<sup>7</sup>

The analysis for onshore wind is based on IRENA's comprehensive update of the onshore wind learning curve and a bottom-up analysis of the technology trends and cost reduction potentials to 2025. The onshore wind learning curve is based on project cost data from over 3 200 wind farms globally installed between 1983 and 2014. This was then supplemented by country averages from secondary data sources where the IRENA Renewable Cost Database coverage is not statistically representative. The comprehensive data compiled from this combination of sources covers 12 countries that account for 87% of cumulative installed onshore wind capacity between 1983 and 2014.

The bottom-up analysis conducted was based on identifying representative wind turbines by major market for 2015 and projecting the evolution in

the representative turbine for that market to 2025 in order to identify performance improvements. A range of consultants' reports were used in order to identify the technology improvements by source (e.g., blades, turbines, foundations, installation, etc.) that could contribute to cost reductions in individual markets, as well as their magnitude.

The analysis of the cost reduction potential for offshore wind is based on analysis conducted by IRENA with experts<sup>8</sup> and supplemented by other sources. Similar to the CSP analysis, within set economic and technical boundaries, a reference offshore wind farm is used to examine the performance of current technologies and their costs, while projecting technology improvements and their impact on performance and cost to 2025. The analysis also takes into account the cost reductions being driven by increased economies of scale, learning from wind farm development and lower financing costs.

---

<sup>7</sup> The DLR report is available from [www.irena.org/costs](http://www.irena.org/costs).

---

<sup>8</sup> For further details, see *Innovation Outlook for Offshore Wind Technology* (IRENA, 2016b).



# 2 SOLAR PHOTOVOLTAICS

## INTRODUCTION

Solar photovoltaics, also called solar cells or just “PV”, are electronic devices that convert sunlight directly into electricity. The modern form of the solar cell was invented in 1954 at Bell Telephone Laboratories. The term “photovoltaics” is derived from the physical process whereby the conversion of light (photons) to electricity (voltage) occurs, the so-called “PV effect”.

In 1966, the National Aeronautics and Space Administration (NASA) of the United States launched the first Orbiting Astronomical Observatory, powered by a 1 kW photovoltaic array. In 1977, global PV production capacity exceeded 500 kW. In 2002, total installed solar PV capacity exceeded 2 GW, and ten years later, in 2012, it surpassed 100 GW. In 2015, new additions of solar PV alone were around 47 GW, with total cumulative installed capacity reaching 222 GW by the end of that year (IRENA, 2016c).

Solar PV has thus come of age. Commercial solutions are now available that can provide competitive power in a complete range of applications. These range from outer space to off-grid and on-grid, and from solar lanterns to utility-scale PV parks. Solar PV modular nature means that panels are within the reach of individuals, co-operatives and small- or medium-sized businesses that want their own generation facilities and the ability to lock in electricity costs.

While small-scale systems represent the largest number of solar PV systems installed, this report focuses on the utility-scale, ground-mount projects. The reason for this is that they still represent the largest share of total installed capacity and, although experiencing a wide range of costs across markets, still have a much more homogeneous cost structure than small-scale systems.

PV cell technologies are usually classified into three generations, depending on the basic material used and their level of commercial maturity:

- » First-generation PV systems (fully commercial): These use wafer-based crystalline silicon (c-Si) technology, monocrystalline silicon (also known as single crystalline) or multicrystalline silicon.<sup>9</sup>
- » Second-generation PV systems: These are based on thin-film PV technologies and generally include three main families: 1) amorphous (a-Si) and micromorph silicon (a-Si/ $\mu$ c-Si); 2) Cadmium-Telluride (CdTe); and 3) Copper-Indium-Selenide (CIS) and Copper-Indium-Gallium-Diselenide (CIGS). These are called “thin-film” because the semiconducting materials used for the production of the cell are only a few micrometres thick. These technologies are being deployed on a commercial scale, but some at low volumes.
- » Third-generation PV systems: These include technologies that are still in a demonstration phase or have not yet been widely commercialised, as well as novel concepts still under development. They also include concentrating PV (CPV) and organic PV cells.

First- and second-generation PV technologies dominate the market today and will continue to do so in the near future, so they are the focus of this report.

Crystalline silicon-based PV modules currently dominate the solar PV market, with at least 90% of new installations by capacity in recent years. This is because their commercial status, relatively high efficiency and low cost make them a very attractive

<sup>9</sup> These two wafer-based PV technologies, differ in the atomic structure (grain size) of the crystalline silicon of the ingots that are used to slice into wafers, which result in different efficiency levels.

choice. Meanwhile, the thin-film solar PV sector has undergone significant consolidation in recent years, and deployment appears to be stabilising at around 4 GW, with 4.1 GW and 3.9 GW deployed in 2012 and 2013, respectively (GlobalData, 2014). About 4.4 GW were estimated to have been produced during 2014 (Fraunhofer ISE, 2016). Although firm data is not yet available, deliveries are likely to have been maintained or even expanded slightly in 2015 given that thin-film leader First Solar reported shipments of 2.9 GW for 2015 (First Solar, 2016a) and CIGS player Solar Frontier reported year on year shipment growth. Thin-film technologies have some advantages under specific operating conditions and have bolstered their competitive position in utility-scale applications. As a result, they are likely to continue to play an important role in the suite of technology options available.

Solar PV is thus now a mainstream technology. Yet, unlike many mature technologies, its costs are continuing to decline, making solar PV increasingly attractive to project developers, particularly in areas with excellent solar resources. The current costs and cost reduction potential out to 2025 are outlined in the following sections.

## CURRENT TECHNOLOGY AND COSTS

The total installed costs of a utility-scale solar PV system are composed of a range of individual components.<sup>10</sup> For ease of comparison, total installed costs are often separated into three categories: module, inverter and balance of system costs. Yet, although useful for tracking the broad trends in installed costs and the relative importance of the three categories, this level of detail is not sufficient to understand cost reduction potentials.

<sup>10</sup> All PV costs in this report are expressed in per-watt direct current (DC). The capacity factors mentioned in this report are expressed as an AC-to-DC value. For the other technologies in this report, capacity factors are expressed in AC-to-AC terms. For a more detailed explanation see also (Lawrence Berkeley National Laboratory (LBNL), 2014) and (Lawrence Berkeley National Laboratory (LBNL), 2015a)

## Balance of system costs

IRENA has collected data on a consistent basis for twelve markets at a detailed level. The data is broken down into three broad categories: non-module and inverter hardware, installation costs, and soft costs. These three categories are composed of more detailed sub-categories in order to provide greater understanding of the drivers of solar PV BoS costs (Table 1).

Data collection challenges mean that high levels of disaggregation are difficult to obtain on a comprehensive and consistent basis over time, when examining trends in individual markets. Analysts are typically left with one-off snapshots of the cost structure of solar PV plants and uncertainty about whether data from different sources are comparable. There are some exceptions to this; for instance, Italy collected comprehensive data from solar PV plants benefiting from government incentives between 2008 and 2013. But in general, it is extremely difficult to access comprehensive time series data on actual cost breakdowns.<sup>11</sup>

Figure 2 therefore shows a snapshot of the utility-scale BoS cost averages in a wide range of PV markets. These markets have been categorized into cost groups, which are used in the cost reduction potential analysis, assuming convergence towards the group's best practice levels. In addition to the usual reasons for variations in installed costs of renewable power generation technologies (IRENA, 2015), the data highlight the importance of the structuring of support policies and their impact on competitive pressures, as well as the benefits that accrue to established and mature markets with a wealth of domestic experience in implementing PV projects.

<sup>11</sup> A range of solar PV market consultants maintain cost models that they calibrate using installer surveys of typical systems. These can provide useful information about trends. Yet, given they are modelled costs with only a sample of installers responding – and are for “typical” rather than actual systems – the usefulness of these data for policy making can be questioned, particularly when levels of costs rather than trends are important.

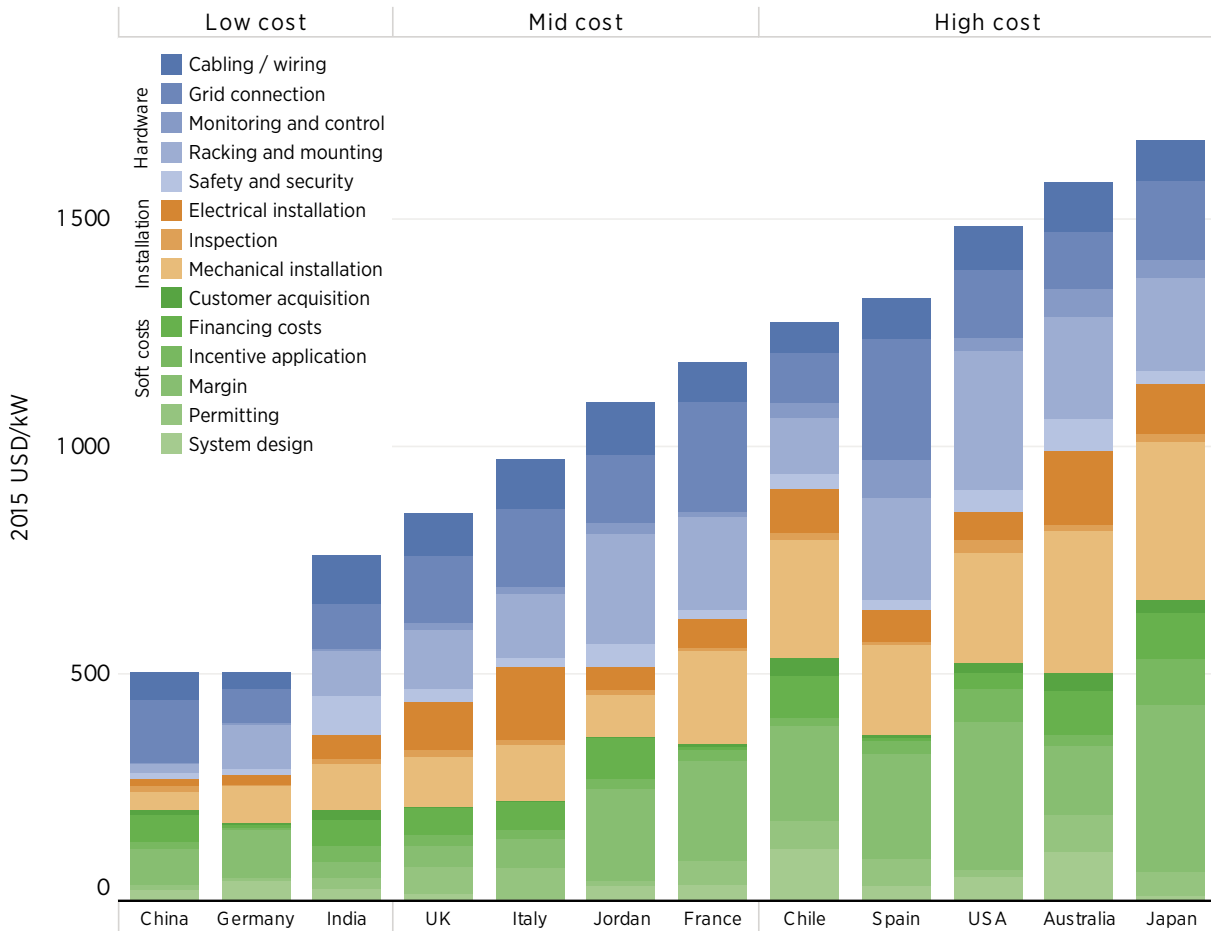


TABLE 1: BALANCE OF SYSTEM COST BREAKDOWN CATEGORIES FOR SOLAR PV

Category	Description
<b>Non-module hardware</b>	
<i>Cabling</i>	<ul style="list-style-type: none"> <li>• All direct current (DC) components , such as DC cables, connectors and DC combiner boxes</li> <li>• All AC low voltage components, such as cables, connectors and AC combiner boxes</li> </ul>
<i>Racking and mounting</i>	<ul style="list-style-type: none"> <li>• Complete mounting system including ramming profiles, foundations and all material for assembling</li> <li>• All material necessary for mounting the inverter and all type of combiner boxes</li> </ul>
<i>Safety and security</i>	<ul style="list-style-type: none"> <li>• Fences</li> <li>• Camera and security system</li> <li>• All equipment fixed installed as theft and/or fire protection</li> </ul>
<i>Grid connection</i>	<ul style="list-style-type: none"> <li>• All medium voltage cables and connectors</li> <li>• Switch gears and control boards</li> <li>• Transformers and/or transformer stations</li> <li>• Substation and housing</li> <li>• Meter(s)</li> </ul>
<i>Monitoring and control</i>	<ul style="list-style-type: none"> <li>• Monitoring system</li> <li>• Meteorological system (e.g., irradiation and temperature sensor)</li> <li>• Supervisory control and data system</li> </ul>
<b>Installation</b>	
<i>Mechanical installation (construction)</i>	<ul style="list-style-type: none"> <li>• Access and internal roads</li> <li>• Preparation for cable routing (e.g., cable trench, cable trunking system)</li> <li>• Installation of mounting/racking system</li> <li>• Installation of solar modules and inverters</li> <li>• Installation of grid connection components</li> <li>• Uploading and transport of components/equipment</li> </ul>
<i>Electrical installation</i>	<ul style="list-style-type: none"> <li>• DC installation (module interconnection and DC cabling)</li> <li>• AC medium voltage installation</li> <li>• Installation of monitoring and control system</li> <li>• Electrical tests (e.g., DC string measurement)</li> </ul>
<i>Inspection (construction supervision)</i>	<ul style="list-style-type: none"> <li>• Construction supervision</li> <li>• Health and safety inspections</li> </ul>
<b>Soft costs</b>	
<i>Incentive application</i>	<ul style="list-style-type: none"> <li>• All costs related to compliance in order to benefit from support policies</li> </ul>
<i>Permitting</i>	<ul style="list-style-type: none"> <li>• All costs for permits necessary for developing, construction and operation</li> <li>• All costs related to environmental regulations</li> </ul>
<i>System design</i>	<ul style="list-style-type: none"> <li>• Costs for geological surveys or structural analysis</li> <li>• Costs for surveyors</li> <li>• Costs for conceptual and detailed design</li> <li>• Costs for preparation of documentation</li> </ul>
<i>Customer acquisition</i>	<ul style="list-style-type: none"> <li>• Costs for project rights, if any</li> <li>• Any type of provision paid in order to get project and/or off-take agreements in place</li> </ul>
<i>Financing costs</i>	<ul style="list-style-type: none"> <li>• All financing costs necessary for development and construction of PV system, such as costs for construction finance</li> </ul>
<i>Margin</i>	<ul style="list-style-type: none"> <li>• Margin for EPC company and/or for project developer for development and construction of PV system includes profit, wages, finance, customer service, legal, human resources, rent, office supplies, purchased corporate professional services and vehicle fees</li> </ul>

Source: IRENA Renewable Cost Database.

FIGURE 2: DETAILED BREAKDOWN OF SOLAR PV BoS COSTS BY COUNTRY, 2015



Source: IRENA Renewable Cost Database.

## Module costs

Solar PV modules have high learning rates<sup>12</sup> (18% to 22%) and rapid deployment – there was around 40% growth in cumulative installed capacity in each of 2012 and 2013 and around 30% in 2014 and 2015. These factors resulted in PV module prices declining by around 80% between the end of 2009 and the end of 2015. In 2011, price declines accelerated as oversupply created a buyer’s market. The price declines then slowed between 2013 and 2015 as manufacturer margins reached more sustainable levels and trade disputes set price floors in some markets.

During Q1 2015, solar PV module prices continued declining by about 15% for crystalline modules and by a slower 4% for thin-film modules. Module prices

<sup>12</sup> A more extensive discussion on the learning curve methodology applied to solar PV can be found in Theologitis & Masson, 2015 and Kersten, *et al.*, 2011.

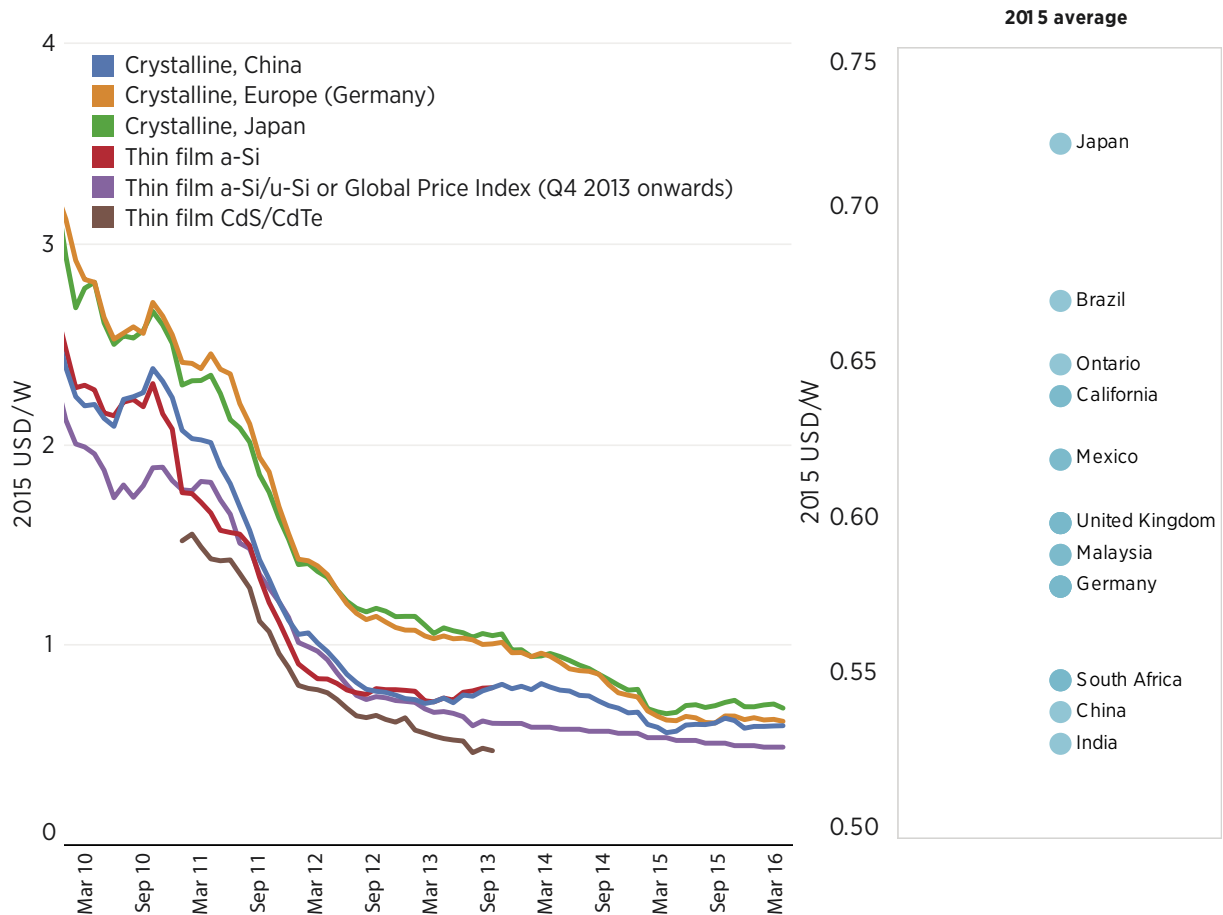
stabilised during Q3 and Q4 2015, with crystalline modules increasing slightly. Thin-film module prices continued their downward trend and decreased 3% during Q2, Q3 and Q4 2015. During early 2016, thin-film prices have stayed around USD 0.5/W. During 2015, weighted average country level module prices ranged from around USD 0.52 to USD 0.72/W (Figure 3).

## Inverter costs

Inverters convert the DC electricity produced by solar PV modules into AC electricity ready for onsite use with AC appliances or injection into the grid. Micro-inverter,<sup>13</sup> string inverter and central

<sup>13</sup> Micro-inverters are module-level power electronics (MLPE) that convert DC electricity into AC electricity at the panel level. They have reached high levels of penetration in the United States residential market. Their presence is also increasing in the commercial solar segment and in other regions.

FIGURE 3: GLOBAL PV MODULE PRICE TRENDS, 2009-2016



Source: GlobalData, 2014; pvXchange, 2016; Photon Consulting, 2016.

inverter technologies are considered in this cost reduction potential analysis.

Central inverters dominate the utility-scale market, although string inverters are increasingly

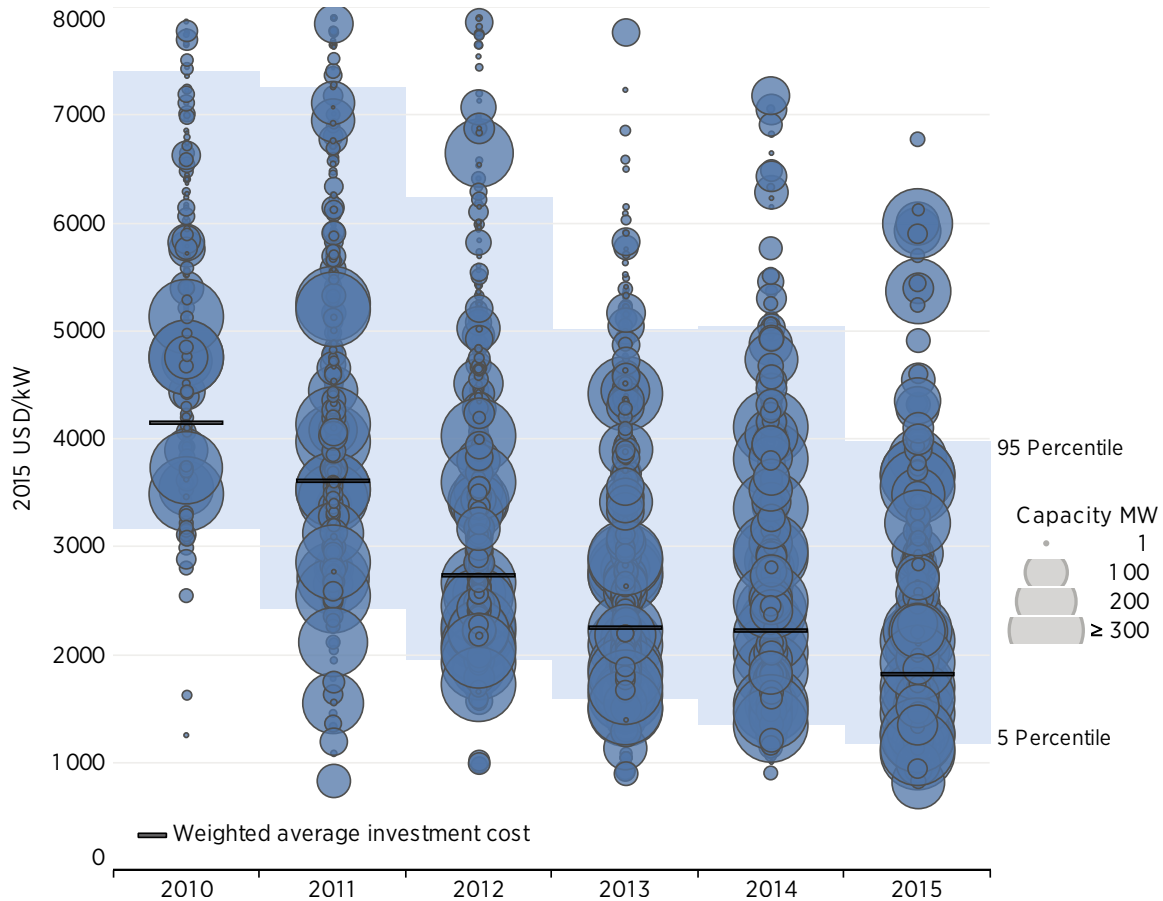
popular. Micro-inverters may find favour for some utility-scale projects by 2025, as they have certain advantages, but they are likely to only make a marginal contribution in the utility-scale sector to 2025. Table 2 presents current global

TABLE 2: CURRENT SOLAR PV INVERTER TECHNOLOGY CHARACTERISTICS AND COSTS

Characteristic/Component	Central inverters	String inverters	Micro-inverters
<b>Power</b>	> 100 kWp	< 100 kWp	Module power range
<b>Efficiency</b>	Up to 98.5%	Up to 98.0%	90.0-95.0%
<b>Global 2015 prices (2015 USD/W)</b>	-0.14	- 0.18	- 0.38
<i>Power electronics</i>	0.015	0.017	0.069
<i>Control card</i>	0.001	0.002	0.010
<i>Filters</i>	0.006	0.006	0.010
<i>Distribution board and others</i>	0.020	0.026	0.110
<i>Indirect costs</i>	0.075	0.100	0.117
<i>Margin</i>	0.023	0.030	0.063
<b>Chinese manufacturers 2015 prices (2015 USD/W)</b>	0.03-0.05	0.06-0.08	n.a.

Source: CREARA, 2016.

**FIGURE 4: TOTAL INSTALLED PV SYSTEM COST AND WEIGHTED AVERAGES FOR UTILITY-SCALE SYSTEMS, 2010-2015**



Source: IRENA Renewable Cost Database.

average prices (excluding China), typical Chinese inverter prices and a cost breakdown by inverter component for the global average data. There is a sharp difference in costs, with suppliers such as Sungrow and Huawei offering prices well below global averages. As these companies increasingly enter new markets and increase their share of installations in Europe, the Middle East and Africa (EMEA) and Japan, they will lower average costs and put significant pressure on local competitors.

Micro-inverters are the most expensive inverters of the three considered, and for the foreseeable future are unlikely to be used at scale outside of residential and commercial systems.

### Total installed costs

Figure 4 shows the total installed PV system cost and weighted averages for utility-scale systems. Significant cost differentials between and within

regions remain (IRENA, 2015). In addition to the usual reasons for relatively wide cost ranges for individual renewable power generation projects, the competitiveness of different markets is the main driver of these cost differentials. The global weighted average total installed cost of utility-scale solar PV projects declined by around 56% between 2010 and 2015. What is noticeable from preliminary 2015 data is that despite modest module price reductions, competitive pressures have started to accelerate a convergence in costs (for example, in BoS costs), as support policies have tried to extract maximum value for customers. This pushed down the weighted average by 18% between 2014 and 2015.

### Capacity factor

There has recently been a welcome trend towards increasing deployment of solar PV in countries and regions with high-quality solar resources. This

## BOX 2

### LCOE, PPAs and FiTs

The LCOE use in this report represents an indicator of the price of electricity required for a project in which revenues would equal costs. This includes making a return on the capital invested equal to the discount rate, while excluding the impact of existing government incentives or financial support mechanisms. For solar and wind technologies in particular, various PPA prices have been announced recently in different locations. With such developments, it can become harder to distinguish between these “record” prices and the LCOE concept as discussed in this report.

Though these very low PPA prices point to the increasing competitiveness of renewable energy sources compared to fossil fuel alternatives, they often cannot be directly compared to the LCOE, nor to the feed-in tariffs (FiTs), which are still available in several locations. The end PPA prices depend on a set of obligations and contract-defined terms that are very dependent on the specific market situation of the project setting. Assumptions made to calculate them usually differ from the more standardised ones used for the LCOE indicator calculations in this report. There is also the chance that if these conditions are not fulfilled, the PPA price may not materialize – if, for example, the independent power producer (IPP) does not fulfil the output requirements or electricity quality. In extreme cases, the deficiencies in the initial winning bid may see a developer walk away from the project as the financial penalties incurred are lower than the expected loss if the project is completed.

As an example of the potential differences between PPA prices and LCOEs, in 2015 a United States solar PV developer agreed to sell power at a record low headline price of USD 0.0387/kWh from a 100 MW solar plant to utility NV Energy. However, it was not widely quoted that this price included a 3% escalation clause and that according to a filing with the Public Utilities Commission of Nevada the LCOE of the project was estimated at about USD 0.047/kWh after the Investment Tax Credit (Public Utilities Commission of Nevada, 2015). Allowing for the impact of the 30% Investment Tax Credit raises the electricity price to around USD 0.066/kWh (70% higher than the headline value). In the case of FiTs, they are also not directly comparable to the PPA contract set prices. For instance, in Germany the current FiT for solar PV is nominal and payable for a period of 20 years, below the economic life of 25 years.

is important, as solar PV capacity factors are determined primarily by the quality of the solar resource and whether single or two-axis tracking is used. Another, lesser, factor is the module technology.<sup>14</sup> System design can also influence the capacity factor, for instance, the inverter load ratio (ILR) also known as DC/AC ratio of PV plants describes the DC array to inverter power ratio. There appears to be a trend in some markets to higher ratios, depending on the project location, design-specific factors and the local electricity market.<sup>15</sup> All things being equal, increasing ILR levels would push down the AC/DC capacity

factor.<sup>16</sup> However, preliminary analysis suggests that the shift to higher irradiation locations and the effect of increased use of tracking seem to have outweighed other factors influencing the global weighted average capacity factor of new utility-scale solar PV, which is estimated to have risen by around one-fifth between 2010 and 2015 (Figure 5).

### O&M costs

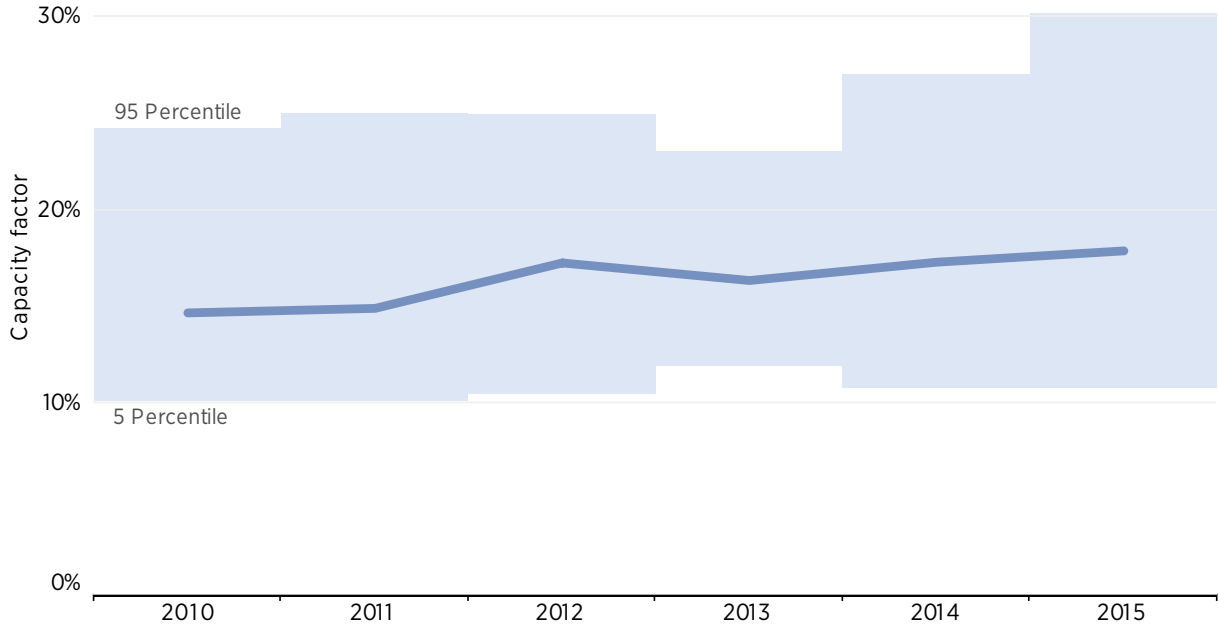
Solar PV O&M costs have not historically been considered a major challenge to their economics.

<sup>14</sup> For instance, thin-film solar PV modules perform better at higher temperatures than do c-Si PV modules.

<sup>15</sup> For a discussion of this trend in the United States, see LBNL, 2015b.

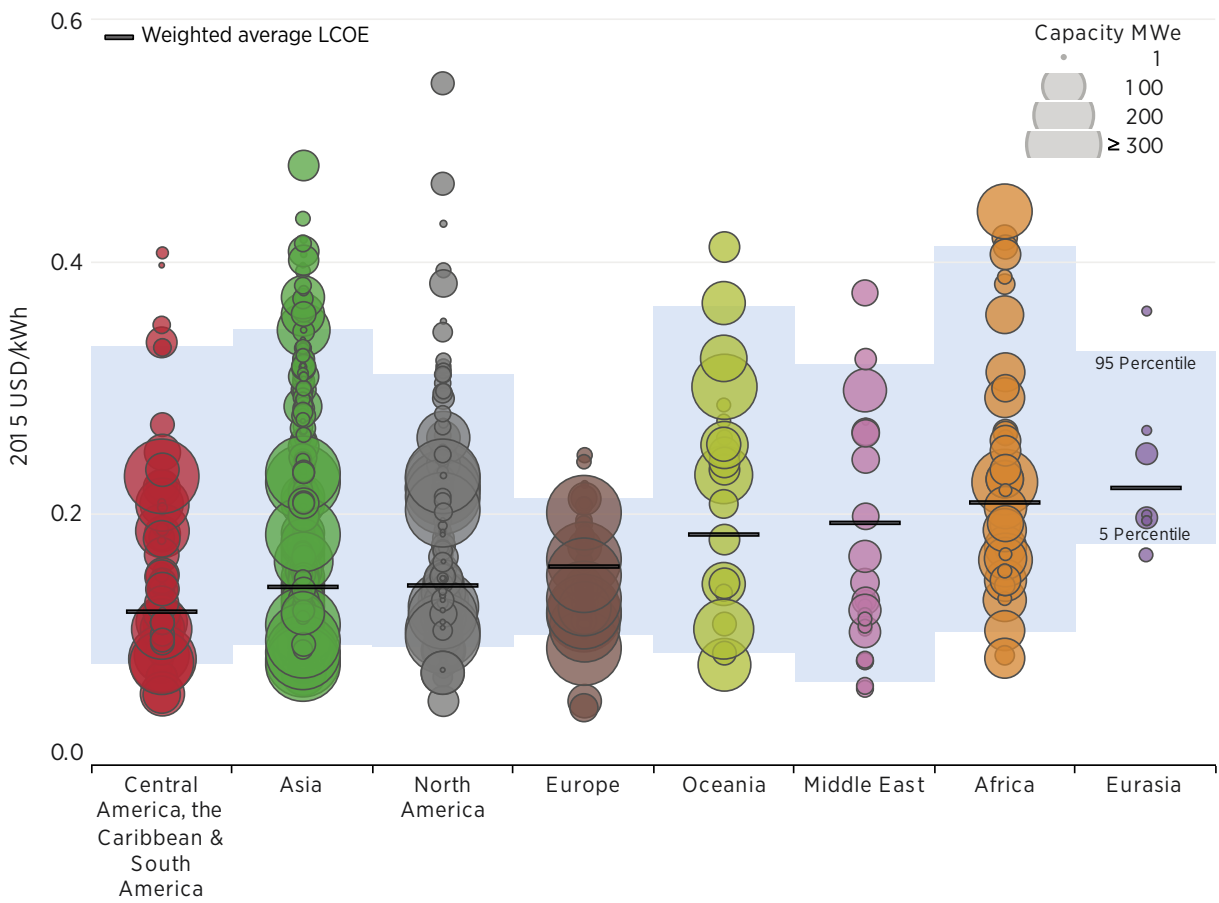
<sup>16</sup> This occurs at times of high irradiation, where inverter limits might result in some curtailment “clipping”. For an ILR of 1.25, “clipping” losses would be minimal to around 1% depending on the location (Good & Johnson, 2016).

**FIGURE 5: GLOBAL WEIGHTED AVERAGE CAPACITY FACTORS FOR UTILITY-SCALE PV SYSTEMS, 2010-2015**



Source: IRENA Renewable Cost Database.

**FIGURE 6: LEVELISED COST OF ELECTRICITY BY PROJECT AND WEIGHTED AVERAGE OF UTILITY-SCALE SOLAR PV SYSTEMS BY REGION, 2014/2015**



Source: IRENA Renewable Cost Database.

Yet, with the rapid fall in solar PV module and installed costs in the last five years, the share of O&M costs in the LCOE of solar PV in some markets has climbed significantly. O&M costs in some OECD markets, such as Germany and the United Kingdom, now account for 20-25% of the LCOE (STA, 2014; deea, 2016). Data for the United Kingdom in 2014 suggested maintenance costs accounted for 45% of total O&M costs, land lease for 18%, local rates/taxes for 15%, insurance for 7%, site security and administration costs for 4% each, and utilities (including purchased electricity) for 2% (STA, 2014). Land lease costs are very site- and market-specific and can be essentially negligible, or quite significant where land constraints are an important challenge, such as in densely populated locations. O&M costs for utility-scale plants in the United States have been reported to be between USD 10 and USD 18/kW per year (Lawrence Berkeley National Laboratory, 2015b; Fu, *et al.*, 2015).

## LCOE trends

The steep decline in total installed costs of utility-scale solar PV in recent years is mirrored in the trend in LCOE. Preliminary data for 2015 suggests that the global average utility-scale LCOE of solar PV declined by around 58% between 2010 and 2015. The LCOE was little changed between 2013 and 2014, as the market moved away from traditional low-cost markets such as Germany to some markets with higher cost structures, notably Japan and the United States. With a weighted average of USD 0.12/kWh, the Central and South American regions had the lowest regional global average, but accounted for just 2% of new global installed capacity in 2015 (Figure 6).

## COST REDUCTION POTENTIAL

This section identifies the cost reduction potential for PV systems. It analyses the module, inverter and BoS system cost reduction potential separately. It then combines these to estimate overall PV system cost reduction out to 2025, using 2015 cost reference levels. In the case of PV modules, a two-fold approach is used to estimate the cost

reduction potential. On the one hand, a bottom-up technology-based analysis of the cost reduction potential along the manufacturing value chain has been conducted. This is evaluated under different scenarios, determined by manufacturing capacity, the effects of economies of scale, and vertical integration for a selection of crystalline and thin-film technologies. Such examination involves the evaluation of materials, electricity, person hours, depreciation costs and other factors. This analysis considers technological improvements and shifts of manufacturing processes and cell technology market shares and their impact on the manufacturing costs. On the other hand, a learning curve analysis, based on historical learning rates for PV modules and market deployment evolution in line with IRENA's REmap 2030 analysis (IRENA, 2016a), provides a complementary view to the bottom-up analysis.

For inverters, the analysis is based on the foreseeable impact of different expected market trends and their influence as drivers of cost reduction in each of the inverter subcomponents. The results of such analysis compare well with reported historical learning rates.

It is in the BoS analysis, however, that both the greatest uncertainty and also the largest opportunity arises. Current markets can be characterised in very broad terms into "low", "medium" and "high" BoS cost groups. The range of costs between these groups is very large and although some of the cost differentials can be explained by structural factors (*e.g.*, low labour costs and/or higher productivity) or the maturity of the local market, in many cases they appear to be driven by inefficiencies in either policy or project development that result in higher costs. A detailed examination of the drivers of the differences in structural costs and what are "efficient" price levels is beyond the scope of this report. Yet, the extent to which markets shift to more "efficient" BoS levels becomes a critical factor of uncertainty in projecting cost reduction potential. What is clear is that the rate of convergence to best practice BoS levels will have the largest impact on overall global cost reductions. It is also a timely reminder that, even more so than for other renewable power technologies, for solar PV, the idea of representative

average global values is something of a mirage, as individual markets must be examined in detail to understand the likely trends.

As a result, the analysis presented below is based on a scenario approach that is driven by three factors. IRENA has examined the possible impact of technology and market drivers in terms of reducing today's best practice BoS cost. In addition, it has been assumed that countries within the same cost group will converge towards the current best-in-class level for that cost group over the next decade. Finally, it is assumed that only new and emerging markets will remain in the high-cost group by 2025, while others shift from high cost to medium cost and from medium cost to low cost structures. The report does not examine the policy measures required to achieve this scenario, nor has it examined in detail the structural cost factors that mean that "efficient" BoS cost structures in different markets will vary, given this would require very detailed country-level analysis beyond the resources for this report. IRENA's analysis reflects the reality that it is extremely unlikely that all markets will converge towards best practice BoS at the same rate and that in most cases, this is not a technological issue, but a market and policy issue. Further detailed work to examine the structural cost differences between solar PV markets, such as those comparing the United States with Germany and Japan (Seel and Wiser, 2014) (Friedman, Margolis, & Seel, 2014), is needed and should be deepened and broadened to other countries in order to identify the causes for cost differentials and policy levers to achieve convergence.

## Total system costs

With continued rapid growth in solar PV deployment to between 1 750 and 2 500 GW by 2030 (IRENA, 2016a), the central case examined here identifies that the global average total installed cost of utility-scale PV systems could fall from around USD 1.8/W in 2015 to USD 0.8/W in 2025, a 57% reduction in 10 years. Taking into account the range of uncertainty around cost drivers, the

decrease could be anywhere between 43-65% from 2015 levels. The majority (about 70%) of the cost reductions are expected to come from lower BoS costs.

For virtually its entire history, the solar PV market's cost reductions have been driven by both module cost declines, given learning rates of 18-22%, and BoS cost reductions. With current module prices in the range of USD 0.5/W and USD 0.7/W, cost reductions from modules in the future will contribute less than in the past to total installed cost reduction potentials, even with very rapid growth in solar PV deployment. Globally, the bulk of the global average total PV system cost reduction opportunities in the next decade will therefore come from continuous BoS cost reductions (Figure 7). Different cost reduction rhythms (mostly BoS reductions) could cause this global average to be between USD 0.63/W and USD 1.04/W. This is between 20% lower and 32% higher than the central estimate. This cost range for 2025 is indicated by the two bars above and below the central estimate for cost in 2025 in Figure 7.

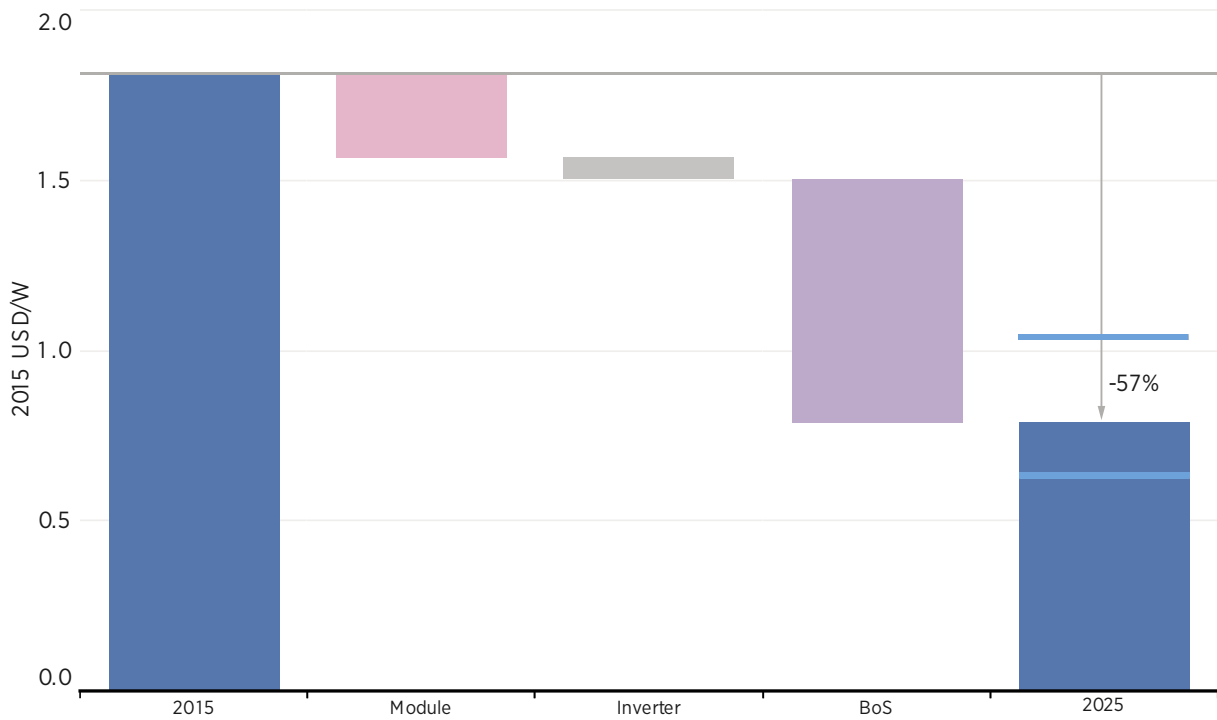
Figure 8 shows the historical and the potential future evolution of the global weighted average total installed costs of utility-scale solar PV with a simple cost breakdown. The share of BoS costs (excluding inverter) between 2009 and 2015 increased from 37% to 60%. Module costs declined more rapidly than BoS costs and contributed around 68% of the total cost reduction. For the period of 2015 to 2025, the central case sees this trend being inverted, with modules contributing about a quarter of the reduction potential. A more detailed analysis of the likely future cost structures is presented in the following sections.

## Balance of system costs

Balance of system costs for utility-scale PV plants could fall by between 55% and 74% between 2015 and 2025 as convergence towards best practice cost structures accelerates under increasing competitive pressures. Both soft costs (e.g.,

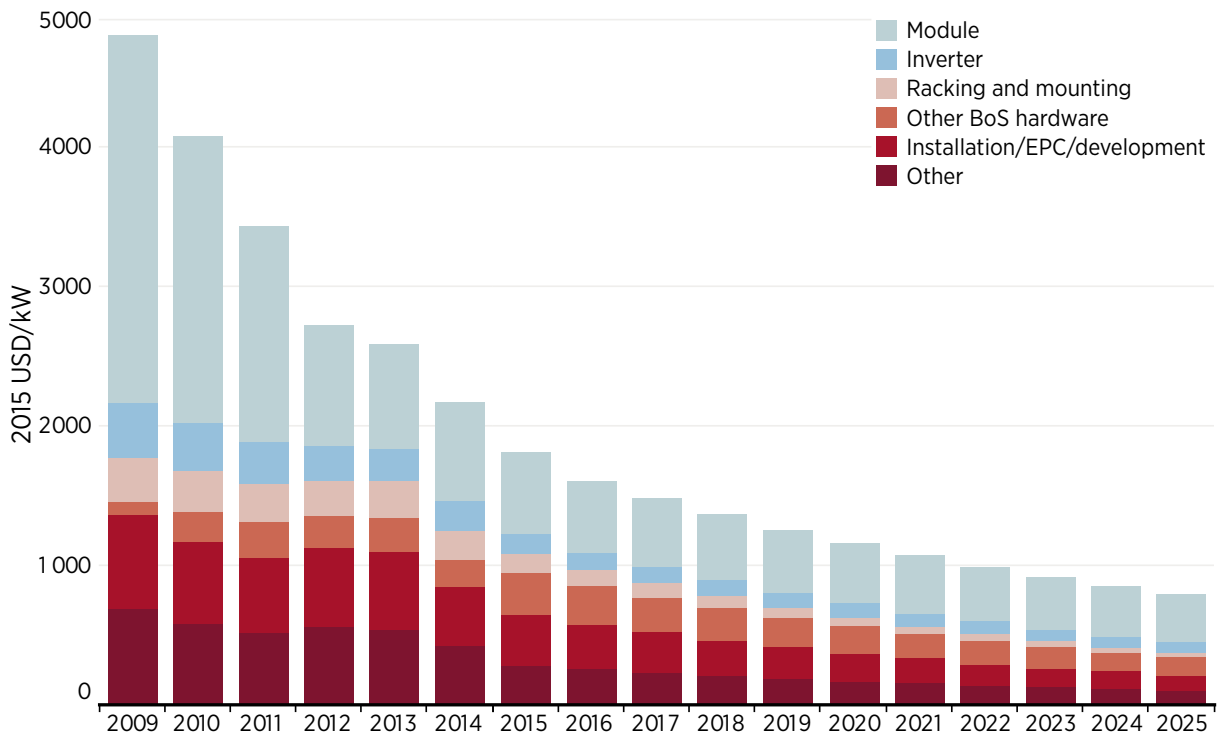


**FIGURE 7: GLOBAL WEIGHTED AVERAGE TOTAL INSTALLED COSTS OF UTILITY-SCALE SOLAR PV SYSTEMS AND COST REDUCTIONS BY SOURCE, 2015-2025**



Source: IRENA analysis.

**FIGURE 8: GLOBAL WEIGHTED AVERAGE TOTAL SYSTEM COSTS BREAKDOWN OF UTILITY-SCALE SOLAR PV SYSTEMS, 2009-2025**



Source: IRENA analysis and Photon Consulting, 2016.

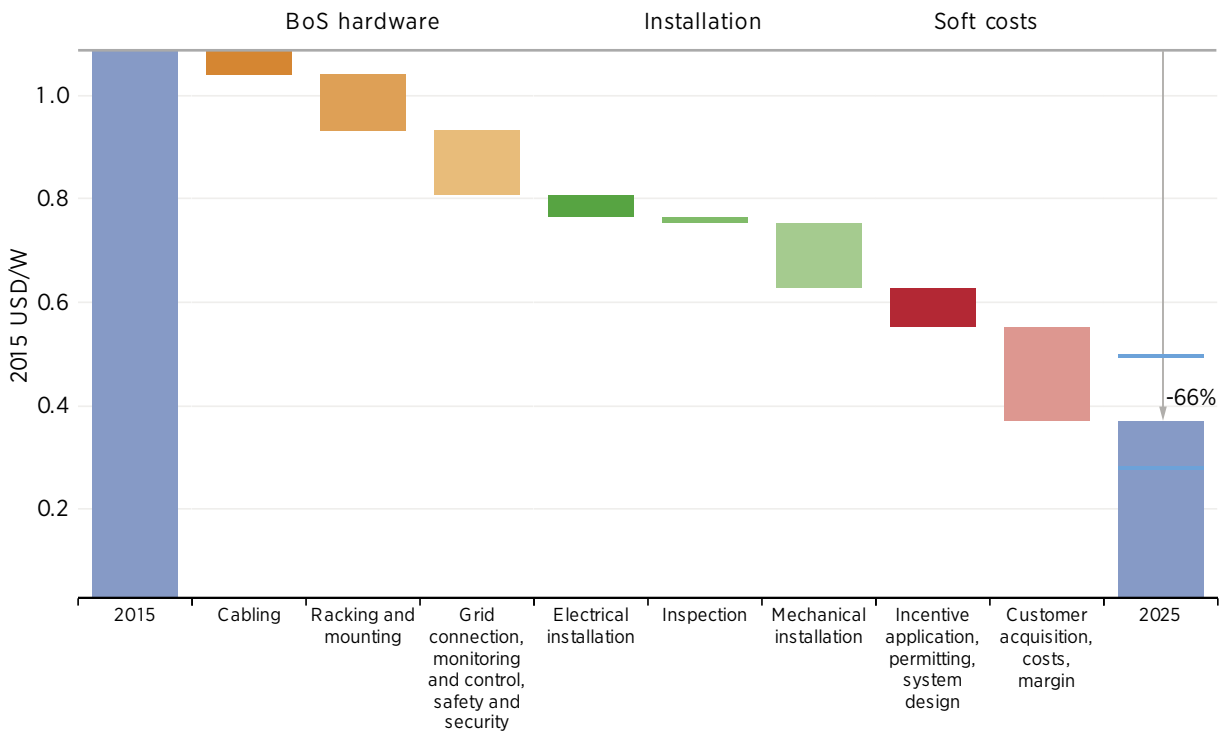
non-hardware or installation BoS costs) and BoS hardware reductions will each account for more than one-third of the total balance of system cost reduction potential (Figure 9).

As the industry matures in more and more countries and competition increases within the markets, there is likely to be a reduction in supply chain margins, as profit and other overhead charges made by suppliers, manufacturers, distributors and retailers declines. This has been the experience in the more cost-mature markets such as Germany, where the per-watt contribution of the utility-scale profit margin is about one-third of that in more expensive markets, such as the United States and Japan. There is also room for cost reductions from the streamlining of the permit and incentive application processes and in system design. In the United States, for example, it is estimated that system design can be reduced by up to 20% through the trend towards modular and scalable “power block” solutions, which are becoming best practice in the utility-scale segment. In the more cost-mature markets, design and layout of the systems has been standardised to a large degree, providing more limited potential.

Utility-scale BoS costs are expected to be in the range of USD 0.3/W to USD 0.5/W in 2025. In the central case examined there is a 66% BoS reduction between 2015 and 2025, putting BoS costs at just under USD 0.4/W by 2025. This BoS cost reduction is mainly driven by convergence towards current best practice levels. Given the wide range of current BoS costs and cost inefficiencies in some markets, around 90% of the BoS cost reduction potential is the result of convergence towards best practice. Additional cost reductions will come from racking, mounting and installation costs as increased efficiency reduces the area and hence materials and labour needs, for a given MW of capacity. The total BoS costs reduction is driven by both soft cost reductions, which could contribute 36% to the total BoS reduction potential, and by BoS hardware cost elements, which contribute 39% of the total. Reduced installation costs account for 25% of the total cost reduction, slightly less than the customer acquisition, financing and margin categories that combined account for 26%.

The BoS hardware cost categories are expected to experience important cost reductions. The racking and mounting hardware category alone is expected

**FIGURE 9: GLOBAL WEIGHTED AVERAGE UTILITY-SCALE SOLAR PV SYSTEMS: BoS COSTS AND COST REDUCTIONS BY SOURCE, 2015-2025**



Source: deea, 2016 and IRENA analysis.

to contribute 15% to the overall BoS reduction potential. Today, many mounting systems are based on appropriate designs, but in many markets, especially newer ones, cost inefficiencies can be quite large. Mounting structures are sometimes heavily over-dimensioned, partly since civil engineers are not familiar with the technology and apply inappropriate security factors in their calculations. This tendency can also be amplified by the inappropriate use of generic local standards due to lack of specific regulations or standardisation for PV. As a result, the per-watt cost of racking can be between two and five times current best practice levels. For ground-mounted systems, there are opportunities to reduce racking costs to best practice levels through the optimisation of mounting foundations.

Reducing cable costs is also a significant cost reduction source to 2025. It is estimated that about three-quarters of the actual cable length depends on the area of the array and thus has the potential to be reduced by module efficiency improvements. The remaining distances are non-reducible connections, bridging distances such as inverter installation point to ground module table. As an example, a relative increase of module efficiency by 20%, which can be assumed as realistic for the considered period, would result in a per-watt cable cost reduction potential of approximately 15%.

The majority of PV systems around the world operate with a maximum voltage level of 1 000 V on the DC side, although sometimes this is restricted to 600 V due to different local standards. Current technical developments with a special focus on larger commercial and utility plants focus on an increase of the nominal maximum voltage to 1 500 V. This will reduce the currents and hence result in a reduction of the actual requirements for cable diameter by around one-third, resulting in material and cost savings. The voltage increase will also result in an increase in power density, due, for example, to a reduction in the number of strings and/or string length per watt. On the other hand, the increase in system voltage requires that all DC components (modules, combiner boxes, connectors, cables) need to be able to bear the higher voltage, which can result in a slight cost

increase. This, however, is overshadowed by the benefits of the use of higher voltages.

In the central case, the installation process in the utility-scale segment is expected to contribute about one-quarter of the total BoS cost reduction potential. The greatest cost reduction is expected to be realised in mechanical installation as inefficiencies in the installation process are relatively common. For a PV plant, this involves the installation of a mounting/racking system, solar modules and inverters, and grid connection components. It also involves civil works, such as roads, foundations and cable trenches in ground-mounted plants. Mechanical installation also includes loading and transport of components or equipment.

Mechanical installation costs are linked to local labour costs, but heavily influenced by the optimisation, or lack thereof, in terms of organisation and planning, logistics and the experience levels of key personnel. An additional component that can contribute to the reduction potential is the optimisation of the hardware used for the installation, which has the effect of reducing installation time by cutting the labour needed. An example of this is the click and slide-in solutions to replace screws in mounting systems or modular systems with standard interfaces. Automatic and programmable piling machines and further optimised mounting tools for the installers are also expected to become more widely used than today.

Efficiencies and material reductions in electrical installation are expected to contribute 6% of the overall BoS cost reduction potential. The improvement in hardware options also has an impact on the electrical work. For example, the so-called “plug and play” cabling connections, as well as designs that reduce manual work around cable laying, will reduce labour costs. To a large extent, many of these measures have already been implemented in the more cost-mature markets, with this trend expected to continue into the newer markets. Productivity increases with rising market maturity and volumes (especially in newer markets) will likely drive costs down further. The utility segment also benefits from increased globalisation of the market, as experienced installers from cost-

mature, but declining, markets enter into new markets, keeping costs low.

## Narrowing BoS current cost differentials

As highlighted, a significant share of the cost reduction opportunity to 2025 globally comes from narrowing current BoS cost differentials. In 2015, Germany and China had the most competitive cost structures for solar PV utility-scale BoS costs at around USD 0.5/W. In contrast, BoS costs in the United States and Japan were much higher, at around USD 1.5 and USD 1.7/W respectively in 2015. By 2025, utility-scale BoS costs by country could fall by 31% in more efficient markets and by up to 69% in less efficient markets, assuming that policies are in place to accelerate convergence in costs.

In addition to the drivers outlined above that are affecting all markets, convergence in BoS costs will be driven by a trend towards more modular, scalable power plant development, built around cost-optimised “power blocks”. The replicable nature of these turnkey projects reduces development costs and standardises hardware needs, reducing engineering effort, as well as unlocking efficiencies in the selection of BoS components. In addition, productivity improvements and process streamlining, which can help eliminate or reduce time and materials spent on various steps in the project delivery process, will also drive cost convergence.

However, the cost reduction drivers for BoS costs will also benefit markets with very efficient cost structures like Germany, where BoS cost reductions<sup>17</sup> of about two-fifths from 2015 levels could be unlocked (Figure 10). In low cost markets the cost reduction emphasis will be on soft cost categories, although some additional hardware cost reductions will be possible, notably due to continued module efficiency improvements. Soft cost reduction potentials will be driven by the on-going pressure on margins and system design improvements. In the utility PV market, soft costs

are expected to account for more than one-third of the total BoS cost reduction potential by 2025.

Even though the majority of the expected cost reductions will come from narrowing cost differentials among countries and the convergence towards current best practice cost levels, there is also reason to expect some additional measures and technological developments that may further reduce the “best practice” cost values out to 2025. Further cost declines beyond today’s best practice cost structures will be driven primarily by:

- » streamlined logistics and more localised supply chains
- » increasing market volume with economies of scale
- » more integrated installation concepts for efficient use of labour and shorter construction periods.

The grid connection, monitoring and control, and safety and security cost category is expected to be the largest contributor to the saving potential shaping future best practice levels. The main components for power evacuation within a utility-scale PV plant are transformers and medium voltage switchgear. In the case of large-scale central inverters, which are used in the majority of these plants, several inverter manufacturers have gained market share in the last two to three years by offering prefabricated central substations. These stations are already relatively optimised in the most advanced markets, but the trend is likely to extend to more markets in the future.

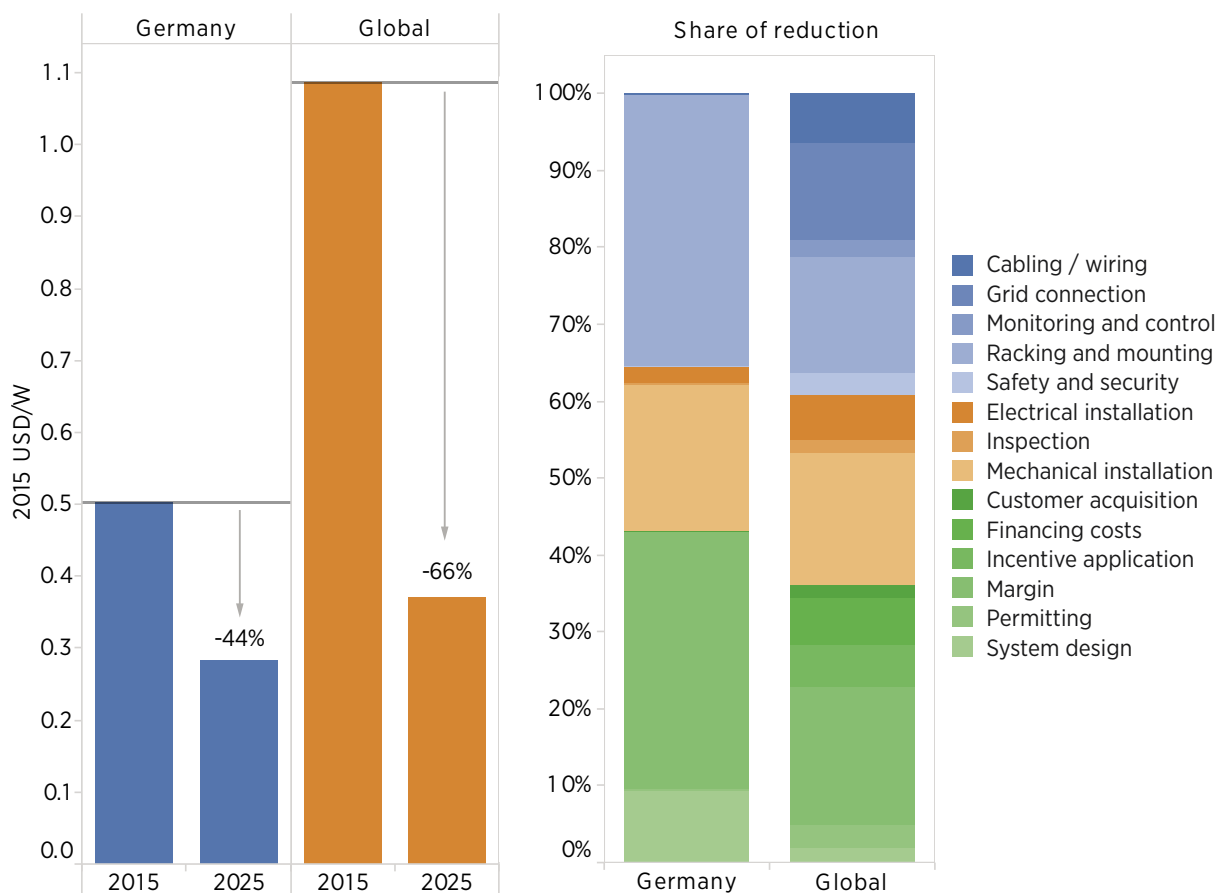
Increases in module efficiency lead to a more compact design of the solar plants and benefit all developers by reducing racking and mounting needs, and cable lengths per MW.

## Module costs to 2025

In spite of significant cost reductions in recent years, module costs will continue to decline. PV module prices may decline by one-third or more from current levels during the next decade,

<sup>17</sup> Assuming the most optimistic cost reduction scenario

FIGURE 10: TECHNICAL BOS COST REDUCTION POTENTIAL FOR GERMANY AND GLOBAL ESTIMATE BY SOURCE, 2015-2025



Source: deea, 2016 and IRENA analysis.

depending on deployment. By 2025, crystalline PV module costs will be in the range of USD 0.28 to USD 0.46/W assuming IRENA's REmap 2030 scenario which foresees the 2030 cumulative installed PV capacity falling within the range of 1 750 to 2 500 GW given learning rates of 18-22%. A bottom-up, technology-based analysis of crystalline technologies points to costs falling to between USD 0.30 to USD 0.41/W by 2025, which also falls within this range (Figure 11). The lower end of these cost ranges slightly exceeds current industry thinking about cost reduction potentials and could result in a similar experience to what happened between 2009 and 2014 when module prices fell faster than anticipated. This range encompasses recent projections for crystalline silicon module costs in 2025 in the vicinity of USD 0.33/W (SEMI, 2016 and Theologitis & Masson, 2015).

This bottom-up analysis assumes a manufacturer vertically integrated from the wafer onwards operating with a production scale of at least 2 GW

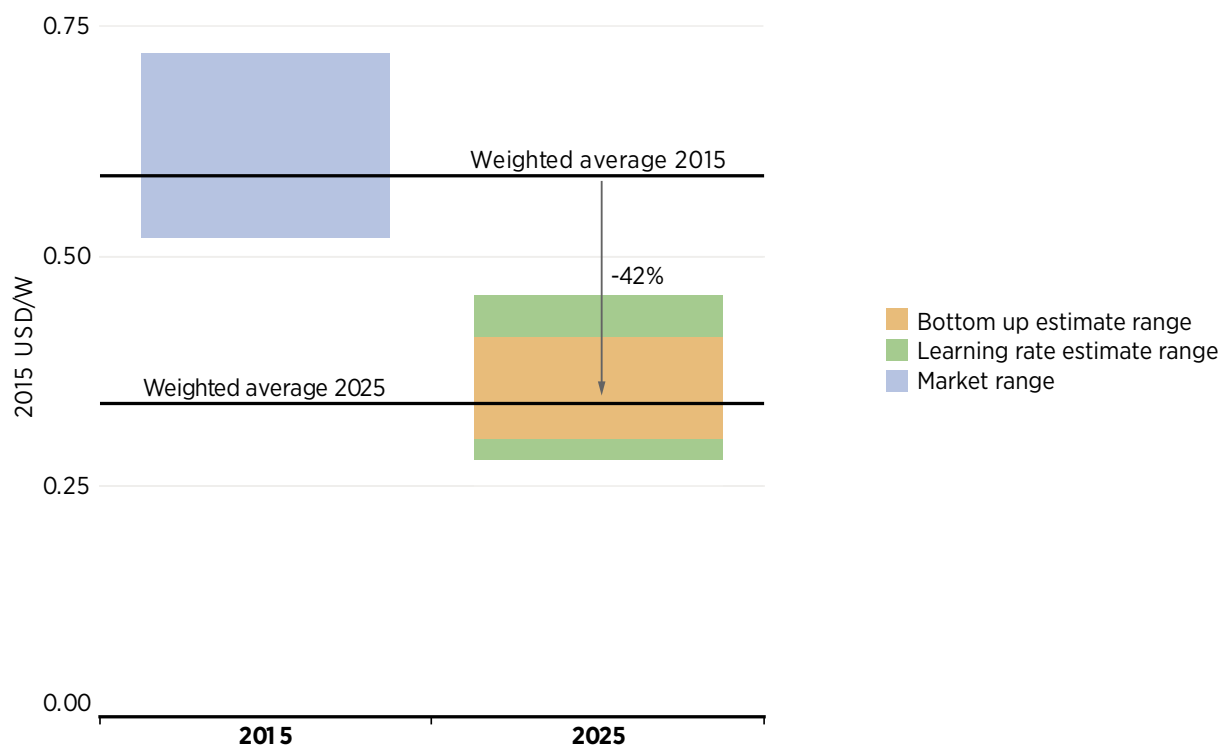
per year in 2025. Module efficiency increases from 16% in 2015 for multicrystalline silicon modules to 19.5% in 2025 (a 22% increase) and from 17% to 21.5% for monocrystalline modules between 2015 to 2025 (a 26% increase).<sup>18</sup> The prospect of smaller scale manufacturing is also plausible for individual manufacturing plant, especially in newer or nascent PV markets. For instance, it may make more economic sense to accept higher manufacturing costs and significantly lower transportation costs for modules from more localised and lower-scale manufacturing.<sup>19</sup>

The largest crystalline module cost reductions out to 2025 are expected to come from polysilicon production (29-34%) and at the cell-to-module value chain steps (28-35%), depending on the crystalline

<sup>18</sup> Best laboratory module efficiencies have been reported recently at 19.2% for multicrystalline and at 22.9% for monocrystalline modules, respectively (Fraunhofer ISE, 2016).

<sup>19</sup> In such circumstances, module manufacturing costs (including margin) from these smaller-scale enterprises could range within USD 0.44/W to USD 0.47/W by 2025, but with lower installed costs due to the reduced transport costs.

FIGURE 11: CURRENT AND POTENTIAL FUTURE COST RANGES FOR CRYSTALLINE MODULES, 2015-2025



Source: CREARA, 2016 and IRENA analysis.

technology. Cost reductions for polysilicon-to-wafer manufacturing (11-12%) and wafer-to-cell manufacturing (25-26%) will be somewhat lower.

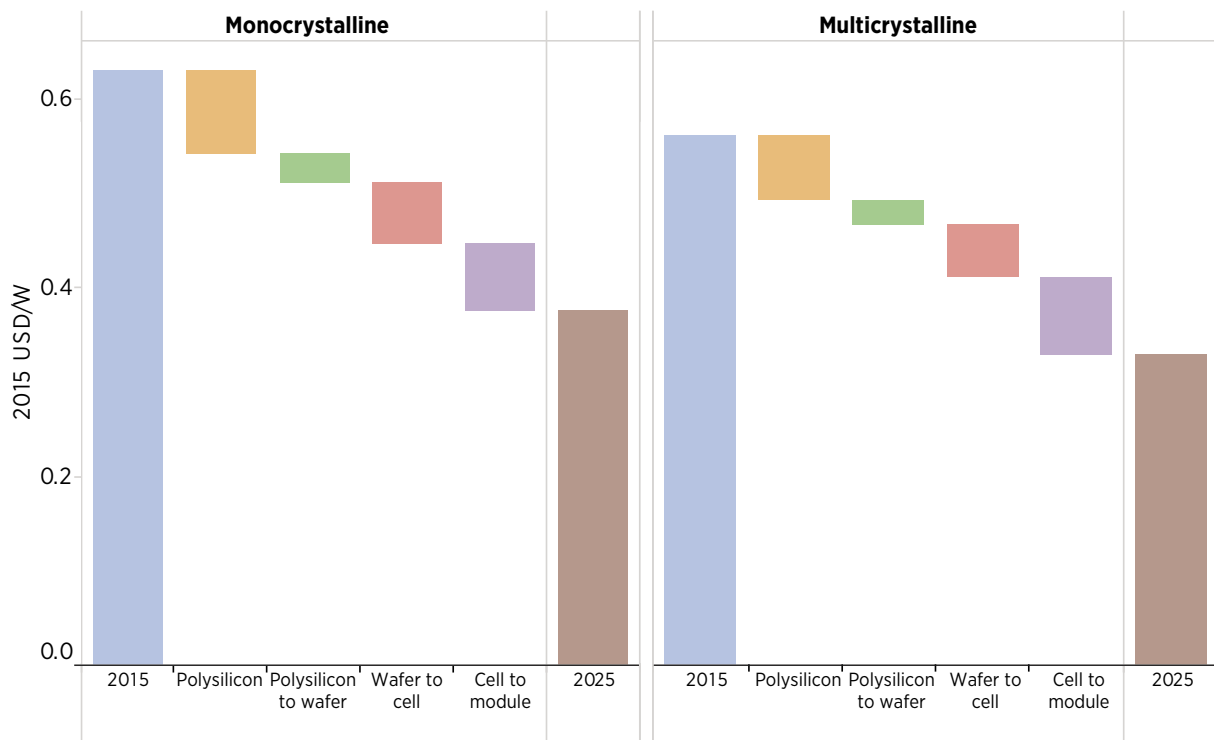
Cheaper polysilicon production can be expected out to 2025 due to reduced electricity and gas consumption and, partially, through the uptake of newer manufacturing processes that reduce material inputs or waste. These may be different from the classic “Siemens” process. As a result, and due to improvements in module efficiency, polysilicon for PV production costs are expected to halve (per watt) by 2025. The next largest cost reduction potential comes from the cell-to-module manufacturing process, where the cost is expected to decline by about one-third for crystalline technologies and to contribute about one-third to the overall reduction potential (Figure 12).

Cost reductions in the polysilicon-to-wafer process will be driven by improved sawing processes, such as a reduction of wire diameter and sawing pitch, that reduce kerf-loss and aid silicon recovery. Diamond coated wires have greater accuracy and also allow the wafer thickness to reach lower levels, thus reducing polysilicon consumption.

From an economic perspective, there are limits, however, to the desirable thinness over the whole production process. A move towards thinner wafers is expected, but also towards better wafer quality, with fewer defects. Improvements in the process control and handling of thinner wafers to avoid breakage will also contribute to a wider adoption of ultrathin wafers and their integration into cell structures (KIC InnoEnergy, 2016). Other cost reduction opportunities relate to the changing landscape of the crystallisation methods as the crystalline silicon material market is diversifying. The continuous Czochralski (CCz) process is likely to gain market presence over the conventional CZ unlocking further cost reductions for wafers. Future wafer cost reductions could also be driven by a combination of higher ingot yields, faster pull speeds, larger-diameter crucibles and increased ingot mass (SEMI, 2016; CREARA, 2016).

Cost reductions in the wafer-to-cell and cell-to-module processes will be driven by innovations that reduce the use of materials in manufacturing and the higher efficiencies of advanced cell architectures. For wafer-to-cell manufacturing, improvements in silver paste recipes, resulting in reduced silver content

FIGURE 12: MONO AND MULTICRYSTALLINE SILICON MODULE COST REDUCTIONS BY SUPPLY CHAIN SOURCE, 2015-2025



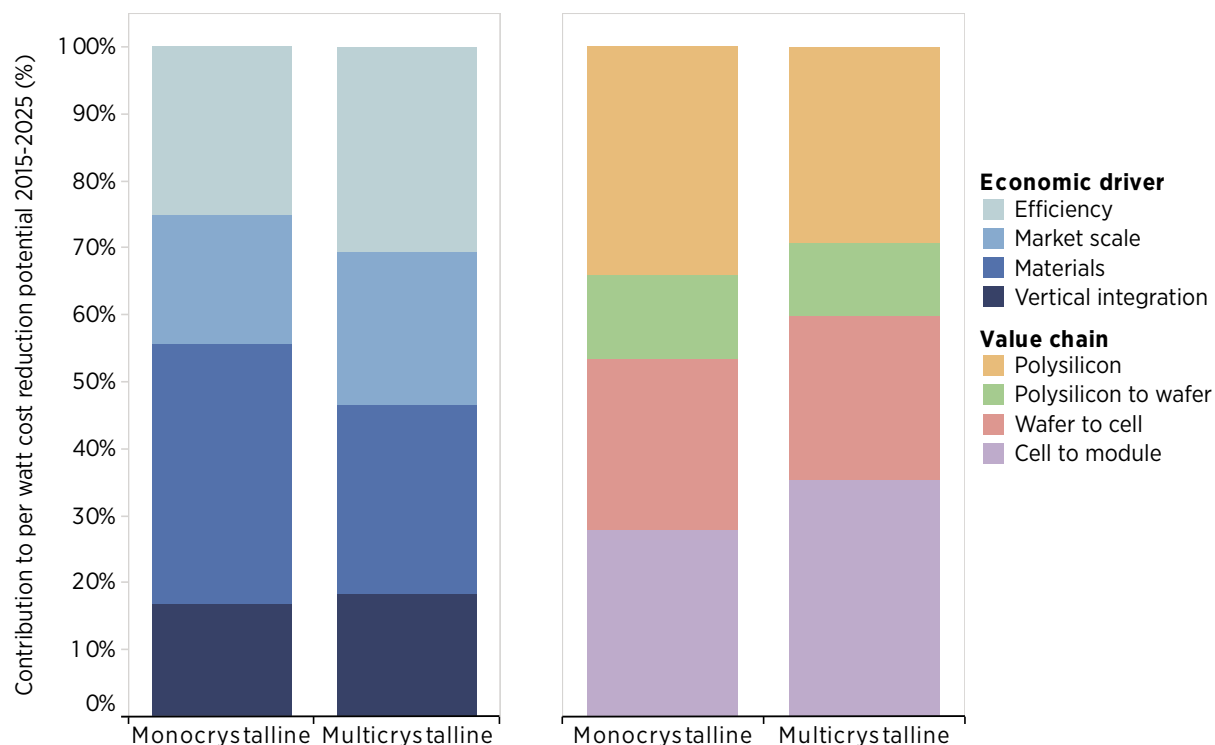
Source: CREARA, 2016 and IRENA analysis.

in PV cells, are one of the most important material reduction drivers (SEMI, 2016). This is because the metallisation pastes that contain silver and aluminum are currently the most process-critical and most expensive non-silicon materials used in crystalline technologies (SEMI, 2016). Total material costs (apart from the wafer) could decrease by up to 35% by 2025 (CREARA, 2016). This reduction will benefit almost all cell architectures currently based on silver paste contacts. Alternatively, novel cell structures with higher efficiency, such as interdigitated back-contact cells (IBC), suppress the use of silver in their design, replacing it with other metallisation methods such as copper plating. These could also reach similar levels of cost in the future, provided their market share increases and economies of scale are realised. These would drive down the current manufacturing costs of such metallisation processes.

Traditional cell structures and both multi- and mono-passivated emitter rear cell (PERC) architectures all still have room for efficiency improvements. These, along with heterojunction cell structures (formed by a junction of both crystalline and amorphous silicon layers), as well as IBC cells with higher efficiencies than the traditional (p-type) multi-junction solar cells,

are expected to at least triple their market presence by 2025. This will drive average efficiency levels higher, too. Continued cell efficiency improvements are an important contributor in reducing material costs for modules. Average cell efficiencies (not to be confused with module efficiencies) of 22% to 25% can be expected in 2025 (compared to 18% to 21% today), but further improvements in heterojunction and back contact cell structures and advances in tandem and multi-junction cell types have the potential to allow cell efficiencies above 25%. The role of increased cell efficiency in terms of cost reduction potential is important, as it may contribute between 25% and 30% of the total potential reduction for modules by increasing wattage for the same cell area. In addition, reductions in material usage from improved manufacturing processes and economies of scale can contribute more than one-half of the potential cost reduction. Figure 13 compares side-by-side the two potential groupings of the cost reduction drivers, by value chain and by market driver for expected reductions of USD 0.26 and USD 0.23/W for monocrystalline and multicrystalline technologies, respectively. Although industry estimates vary on the contribution of individual drivers, cost reductions related to materials for

**FIGURE 13: SHARE OF COST REDUCTIONS BY ECONOMIC DRIVERS AND VALUE CHAIN FOR MONO AND MULTICRYSTALLINE MODULES, 2015-2025**



Source: CREARA, 2016 and IRENA analysis.

monocrystalline modules are expected to contribute about 10% more to the reduction potential in comparison to multicrystalline. On the value chain side, polysilicon savings are expected to contribute about 34% to the total reduction potential, while 28% of savings would come from the cell to module process of monocrystalline modules. For multicrystalline technology these contributions are reversed, with more than 35% cost reductions attributable to the cell to module process.

For thin-film technologies, improvements in efficiency levels, manufacturing equipment innovations and economies of scale, along with learning effects, are expected to drive the cost of CIGS modules down. This could result in CIGS modules reaching USD 0.36/W by 2025, some 32% below their 2015 level. In the case of CdTe modules, such improvements would result in costs 35% below those of 2015, falling to USD 0.26/W. As an example, First Solar has reported a module efficiency roadmap up to 2020 that expects a 41% relative efficiency increase from the 2013 reported levels (First Solar, 2016b). This would mean efficiency levels of above 18% for the 2020-2025 period, with efficiency gains contributing at least

half of the cost reduction potential over the 2015-2025 period. The rest of the cost reductions can be attributed to utilisation, line rate increases and scale-related cost reductions.

### Inverter costs to 2025

The inverter manufacturing process is usually vertically integrated. Inverters consist of the following components:

- » power electronics materials
- » control cards
- » magnetic filters
- » a distribution board, including the encapsulating materials and the rest of the electronics (switches, contactors, probes, wires and other materials to integrate the inverter).

With increased global PV deployment, inverters have followed a strong cost reduction path. The global average cost for inverters dropped from



TABLE 3: TRENDS INFLUENCING THE COSTS OF INVERTER TECHNOLOGIES TO 2025

Inverter trend	Key influence
<b>Higher PV module isolation (&lt;1 500 V)</b>	<ul style="list-style-type: none"> <li>• With little hardware changes, a higher bus DC can be achieved in the PV inverter. This implies a bigger AC connection and a higher power in the inverter (with the same electric current).</li> <li>• This would not only reduce inverter costs but also the amount of transformers and medium voltage cells needed.</li> </ul>
<b>Off-grid market (Africa, South America, etc.)</b>	<ul style="list-style-type: none"> <li>• Manufacturers may be interested in investing in factories where manufacturing costs and transportation may be reduced.</li> </ul>
<b>Asian technologies</b>	<ul style="list-style-type: none"> <li>• Traditionally, inverters installed in Europe have been mainly German, Spanish and Italian, while in the United States, they have been essentially American (although with some European models). However, in recent years there is an increasing presence of low-cost Asian players in international markets.</li> </ul>
<b>Other trends</b>	<ul style="list-style-type: none"> <li>• Adoption of flexible AC transmission systems (FACTS).</li> <li>• Adoption of other sectors' inverters (e.g., wind energy and frequency modifiers).</li> <li>• Adaptation of PV inverters to integrate energy storage.</li> </ul>

Source: CREARA, 2016; IRENA analysis.

above 1 USD/W in 1990 to USD 0.14-0.18/W<sup>20</sup> in 2015, although lower costs have also been reported. The learning rate of inverters has recently been reported at values ranging from 18-20% (Vartiainen, Masson and Breyer, 2015 and Fraunhofer ISE, 2015), which is in line with current module learning rate estimates.

The cost reduction potential for solar PV inverter technologies out to 2025 will be driven by two types of cost reduction opportunities: technological progress, which will result in inverters becoming more like standardised commodities, and economies of scale. The latter will be driven by the increased presence of Asian players in international markets.

Some of the most important trends pushing down the cost of inverters are summarised in Table 3. Such trends include, for example, hardware changes enabling higher bus DC up to 1 500 V and the associated higher PV module isolation (Villegas Nuñez, 2013). Another trend is the shift to newer manufacturing locations, with lower labour

costs and savings in transport as products originate closer to their markets. The analysis also accounts for the expected increase in economies of scale and commoditisation due to larger deployment and increased adoption of flexible AC transmission systems (FACTS), which help compensate reactive power. FACTS can be introduced to the utility-scale PV market, connecting them as inverters and making the power transformer unnecessary. This reduces overall costs.

As a result of these trends, costs for inverters could fall by 33-39% between 2015 and 2025, as Table 4 shows.

From a learning curve perspective, the estimated cost decreases are in line with a learning rate of about 19%. As a benchmark for these results, analysts have estimated a decrease of inverter costs of around 40% towards 2025, with annual price reductions in the order of 8-9% per annum to 2020 (IHS, 2015; GTM Research, 2015; and GlobalData, 2015).

<sup>20</sup> This range excludes micro-inverters.

TABLE 4: EXPECTED COST REDUCTION OF INVERTER TECHNOLOGIES TO 2025

Characteristic/Component	Central inverters	String inverters	Micro-inverters
<b>Global price (2015)</b>	- USD 0.14 USD/W	- USD 0.18 USD/W	- USD 0.38 USD/W
<b>Change to 2025</b>	-39%	-33%	-30%
<b>Global price (2025)</b>	- USD 0.09 USD/W	- USD 0.12 USD/W	- USD 0.27 USD/W
<i>Of which:</i>			
<i>Power electronics</i>	0.010	0.012	0.048
<i>Control card</i>	0.001	0.001	0.009
<i>Filters</i>	0.004	0.004	0.007
<i>Distribution board and others</i>	0.016	0.018	0.077
<i>Indirect costs</i>	0.041	0.065	0.082
<i>Margin</i>	0.014	0.020	0.045

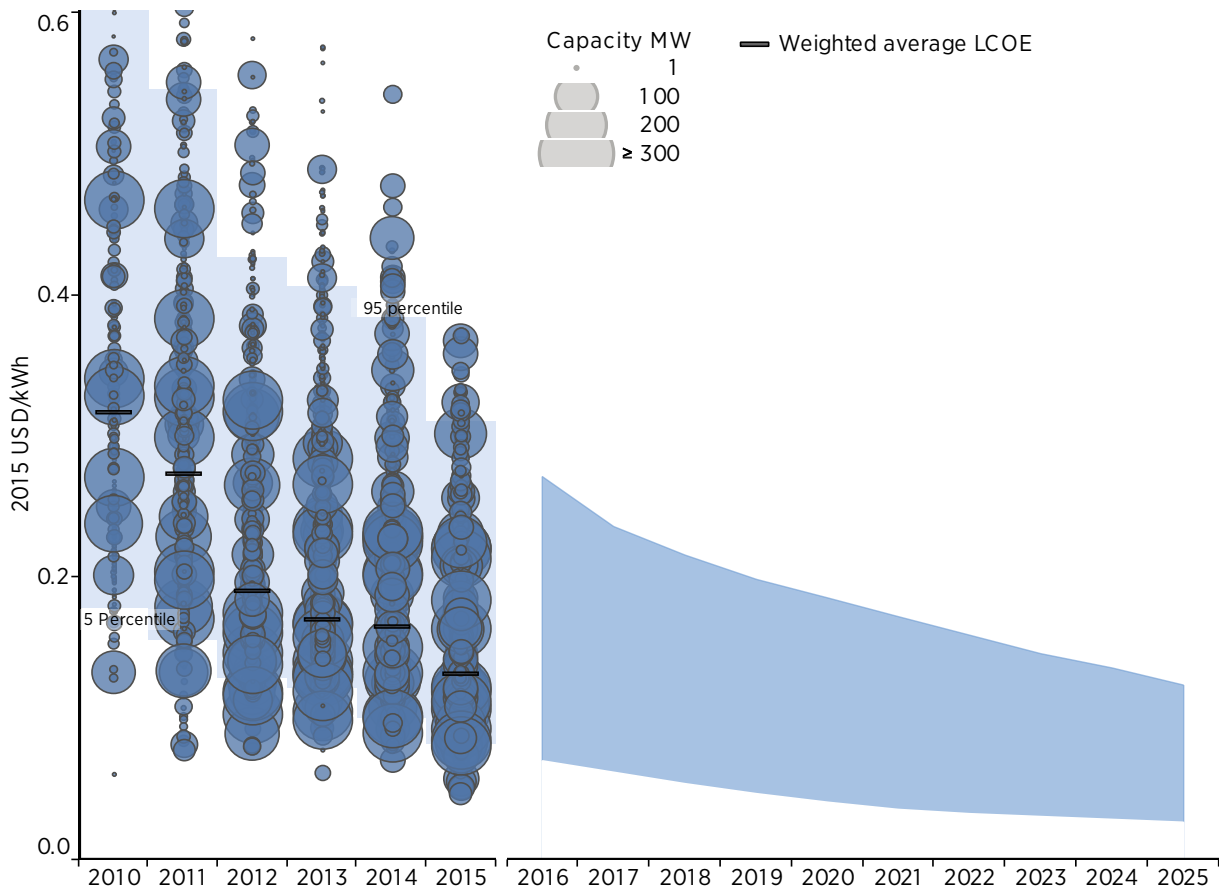
Source: CREARA, 2016.

### LCOE development to 2025

The global LCOE range of utility-scale PV systems is expected to continue its downward trend. This decline will be driven by more efficient future cost structures caused by lower BoS costs, as well as by continued reductions in module costs towards 2025.

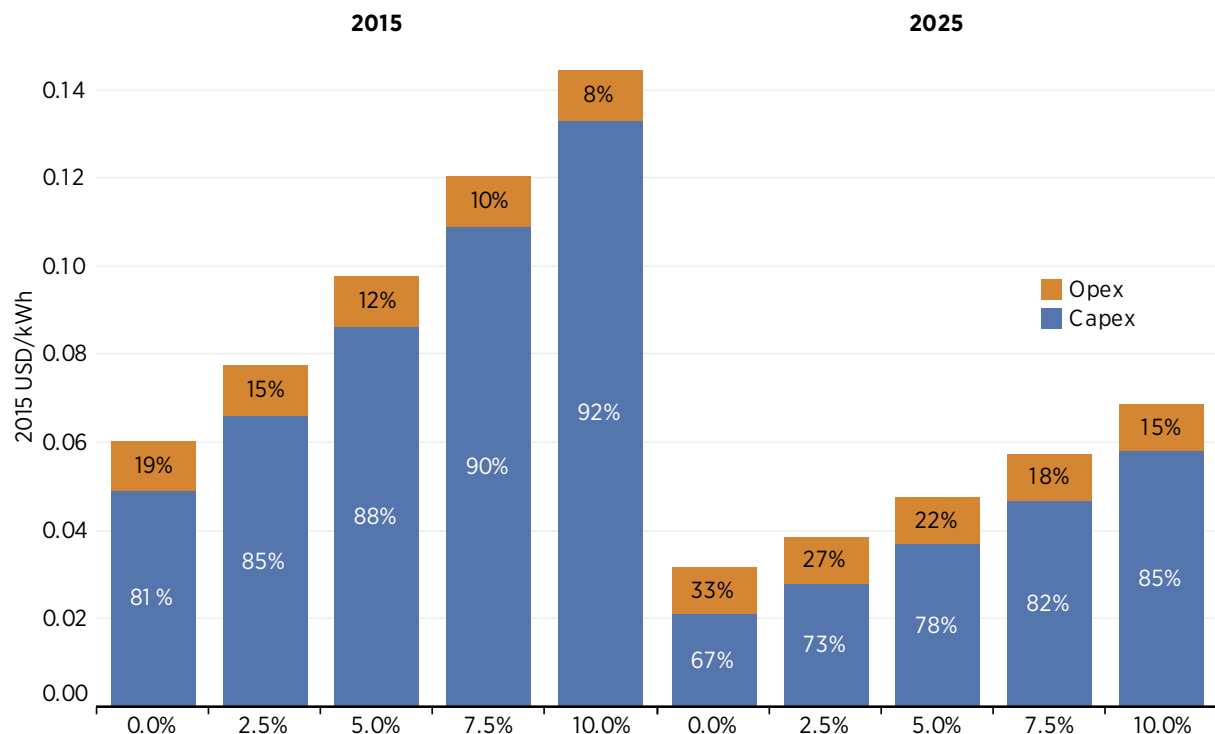
Figure 14 shows the LCOE range for utility-scale PV projects from 2010-2015 (left-hand side) and a projection towards 2025 (right-hand side). From 2010-2015, the capacity weighted average LCOE decreased 58%. The LCOE of utility-scale PV systems is expected to continue its downward trend. The global weighted average LCOE of solar

FIGURE 14: GLOBAL UTILITY-SCALE SOLAR PV LCOE RANGE, 2010-2025



Source: IRENA Renewable Cost Database and IRENA analysis.

FIGURE 15: GLOBAL UTILITY-SCALE SOLAR PV LCOE BY WACC, 2015-2025

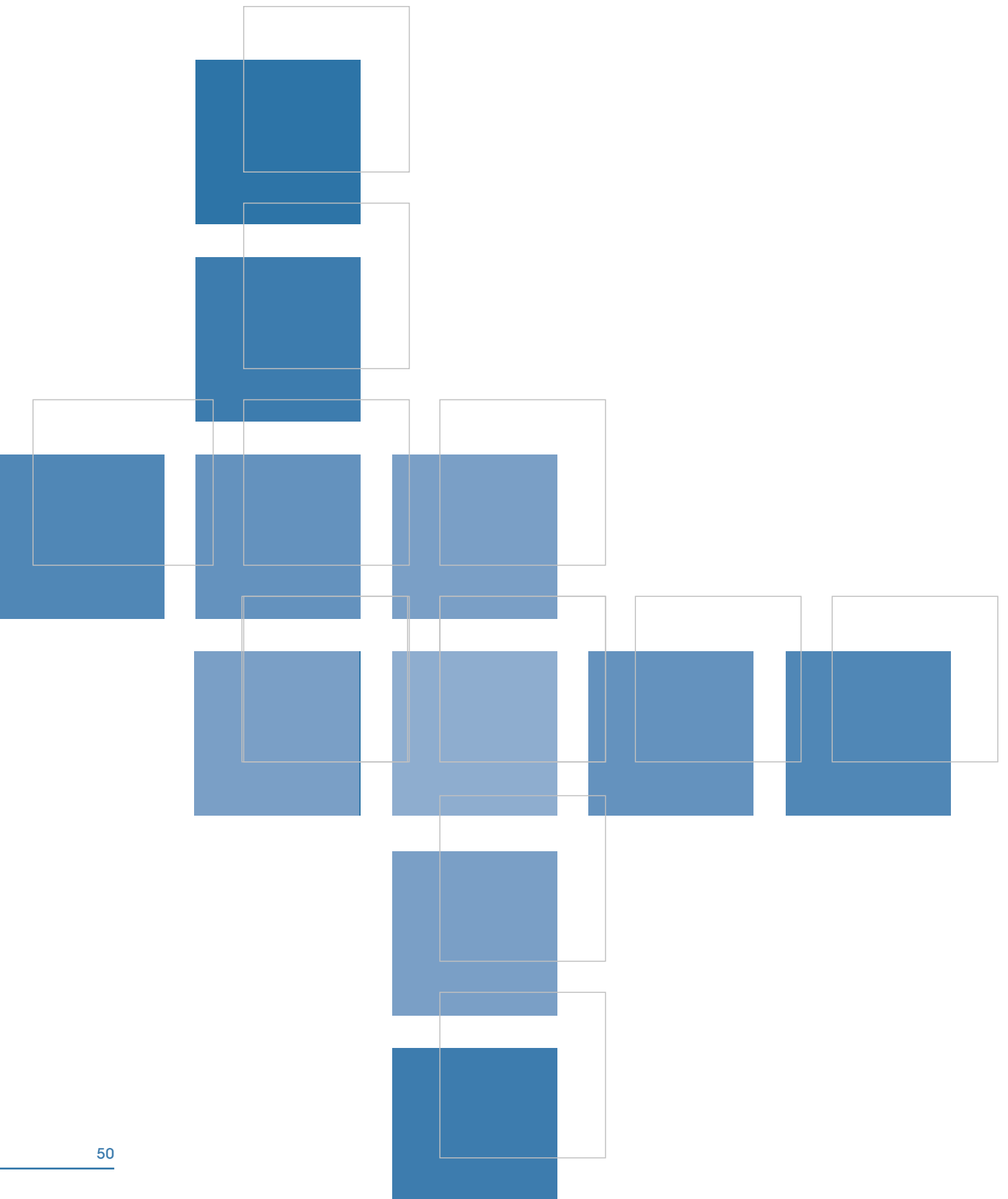


Source: IRENA analysis.

PV could decline from USD 0.13/kWh in 2015 to USD 0.055/kWh by 2025 (a 59% decline), assuming the installed cost reduction potential detailed in this report, O&M costs declines and increase in the global weighted average capacity factor from 17.9% in 2015 to 19.3% in 2025. By 2025, the 5<sup>th</sup> to 95<sup>th</sup> percentile LCOE cost ranges for individual utility-scale solar PV projects could fall to between USD 0.03 to USD 0.12/kWh by 2025, 68% and 60% lower than the 5<sup>th</sup> and 95<sup>th</sup> percentile in 2015, respectively. This trend is in line with recent PPA and tender results for solar PV around the world, bearing in mind that they are not necessarily directly comparable with an LCOE calculation, notably if the WACC of the project is lower than assumed here. In 2015 and 2016, record low prices were set for projects to come on line in 2017 and 2018 in the United Arab Emirates, (USD 0.058/kWh), in Peru (USD 0.048/kWh), Mexico (a median price of USD 0.045/kWh). In May 2016, an auction of 800 MW of solar PV in Dubai attracted a bid as low as USD 0.03/kWh, although the winning bid has not

been announced. This LCOE projected range also accounts for all the differences among potential projects based on 2015 characteristics, including irradiation levels in the different countries and the range of expected PV systems' total investment costs based on the analysis in the preceding sections. The lower boundary of the projected LCOE range in Figure 14 is not inconsistent with other estimates (SEMI, 2016), in which levelised costs by 2026 were estimated in the range of USD 0.03 to USD 0.06/kWh.

Figure 15 shows a sensitivity analysis for the LCOE to different WACC levels. The share of capital expenditures in 2015 ranges from 81% at the lowest cost of capital level to about 92% at 10% WACC. In the 2025 scenario, operating costs have consistently higher contributions to the LCOE of PV compared to 2015. At a WACC of 10%, operational costs are expected to contribute about 15% of the LCOE of utility-scale. This rises to 27% at a WACC of 2.5%.



# 3 ONSHORE WIND

## INTRODUCTION

In 1979, Danish manufacturers Vestas, Nordtank, Kuriant and Bonus ushered in the modern era of wind power with the mass production of large wind turbines to produce electricity. These early wind turbines typically had small capacities by today's standards – 10-30 kW – but they pioneered the development of the modern wind power industry. Today, onshore wind is an increasingly competitive technology deployed in over 100 countries.

Wind power technologies have two main characteristics: the axis of the turbine and the location. The axis of the turbine can be vertical or horizontal and the location can be onshore or offshore. Virtually all onshore wind turbines are horizontal-axis turbines, predominantly using three blades and with the blades “upwind”.<sup>21</sup> The key elements determining the amount of electricity generated by a wind turbine are the nameplate capacity (in kW or MW), the quality and characteristics of the wind resource, the hub height and the rotor diameter.

Capital costs, financing costs, O&M costs and expected annual electricity production are the main drivers of the LCOE. Careful assessment of all these factors over the lifetime of a project allows a comprehensive perspective on the costs of wind energy.

Wind power has experienced a somewhat unheralded revolution since 2008-09. Between 2008 and 2015, a virtuous circle of improved technologies, such as higher hub heights and larger swept areas by blades, has increased capacity factors for a given wind resource. At the same time, installed costs have fallen as wind turbine prices have declined from their peak in 2008-09. Balance of project costs have also declined, with

these factors all driving down the LCOE of wind and spurring increased deployment.

However, although wind power is now one of the most competitive options for new power generation capacity, differences in installed cost ranges within and between countries remain significant (IRENA, 2015). As a result, but also due to continued technology improvements and manufacturing innovations, significant cost reduction opportunities remain. Cost reductions will come from shifting to best practices and from continued technology improvements. They can also be obtained from increased scale and competitiveness in the wind power supply chain, as regional and global markets grow.

The following sections present the historical evolution of onshore wind energy costs. They also assess the drivers of future cost reductions, both in capital costs and the LCOE, and in the improvement of capacity factors in the period up to 2025.

## WIND POWER DEPLOYMENT

Total installed onshore wind capacity reached 420 GW globally at the end of 2015 (IRENA, 2016c). Cumulative installed capacity has increased by almost 25% per year over the last decade. China maintains the largest share of onshore wind capacity in the world, at 34% at the end of 2015. This is followed by the United States (17%), Germany (10%), India (6%) and Spain (5%). The year 2015 marked a new record (59 GW) in net additions of onshore wind capacity, itself compounding the record year of 2014. In 2015, China accounted for 51% of global new additions, followed by the United States (13%), Germany (6%), Brazil (5%) and India (4%). Strong growth in China (30 GW) and the United States (7.7 GW) accounted for around 63% of net additions in 2015.

<sup>21</sup> For more information on wind power technologies and resources see IRENA, 2012, Chapter 2.

China is expected to add more than 20 GW a year from 2016 to 2020, with this figure set in national targets and supported by provincial governments (MAKE Consulting, 2016a). With policy support renewed for the medium-term, the United States will add on average more than 7 GW a year up to 2020 (MAKE Consulting, 2016a). Brazil had a solid installation record in 2015 (2.8 GW) and is set to continue installing more than 2.5 GW a year in the coming five years, although economic uncertainty might dent this estimate (MAKE Consulting, 2016a). Germany installed more than 3.5 GW of onshore wind in 2015.

## CURRENT TECHNOLOGY AND COSTS

Many different design concepts of the horizontal-axis wind turbine are in use. The most common is a three-bladed, stall- or pitch-regulated, horizontal-axis machine operating at near-fixed rotational speed. However, other concepts for generation are available. Gearless, “direct drive” turbines with variable speed generator designs, for example, have a significant market share (IRENA, 2015). Wind

turbines will typically start generating electricity at a wind speed of 3 to 5 metres per second (m/s), reach maximum power at 15 m/s and generally cut-out at a wind speed of around 25 m/s.<sup>22</sup>

Wind turbines (including towers and installation) are the main cost components in developing wind projects. The turbines can account for between 64% and as much as 84% of an onshore wind project’s total installed costs (Blanco, 2009; EWEA, 2009; Douglas-Westwood, 2010; and MAKE Consulting, 2011). The more predominant range, however, is 64-74% of installed costs. Figure 16 presents the evolution of total installed costs by category in Germany between 1998 and 2012.<sup>23</sup>

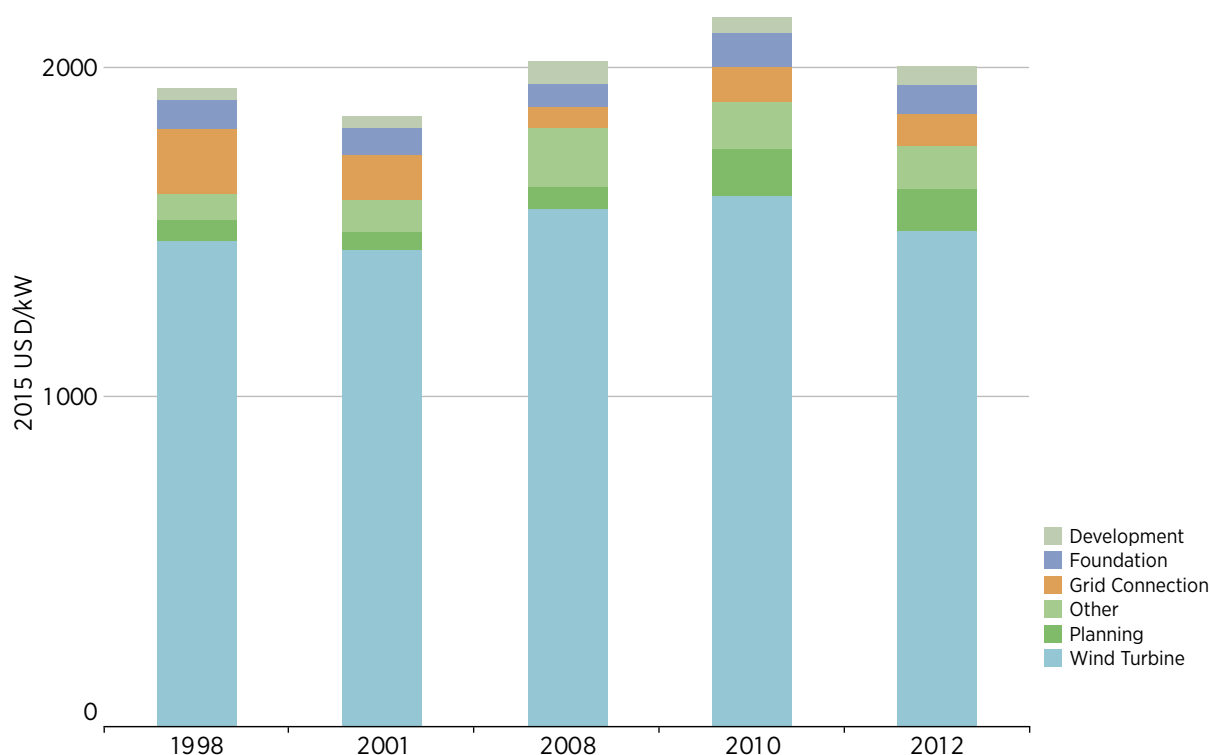
The capital costs of a wind power plant can be assigned to four major categories:

- » turbine cost: rotor blades, gearbox, generator, power converter, nacelle, tower and transformer;

<sup>22</sup> The relationship of power output to wind speed is referred to as the “power curve” of a turbine.

<sup>23</sup> An example of a very detailed cost breakdown for onshore wind can be found in IRENA, 2013, Chapter 4, Table 4.1.

FIGURE 16: TOTAL INSTALLED COST BREAKDOWN FOR ONSHORE WIND PROJECTS, IN GERMANY, 1998-2012



Source: Deutsche Windguard, 2013.

- » civil works: construction works for site preparation and foundations for towers;
- » grid connection costs: transformers, substations and connection to the local distribution or transmission network;
- » planning and project costs: development cost and fees, licenses, financial closing costs, feasibility and development studies, legal fees, owners' insurance, debt service reserve and construction management.

The most important recent developments in the wind market have been related to technological improvements. These ensure a range of wind turbine options are available that allow project developers to choose the designs that yield the lowest LCOE, given the characteristics of the local site.

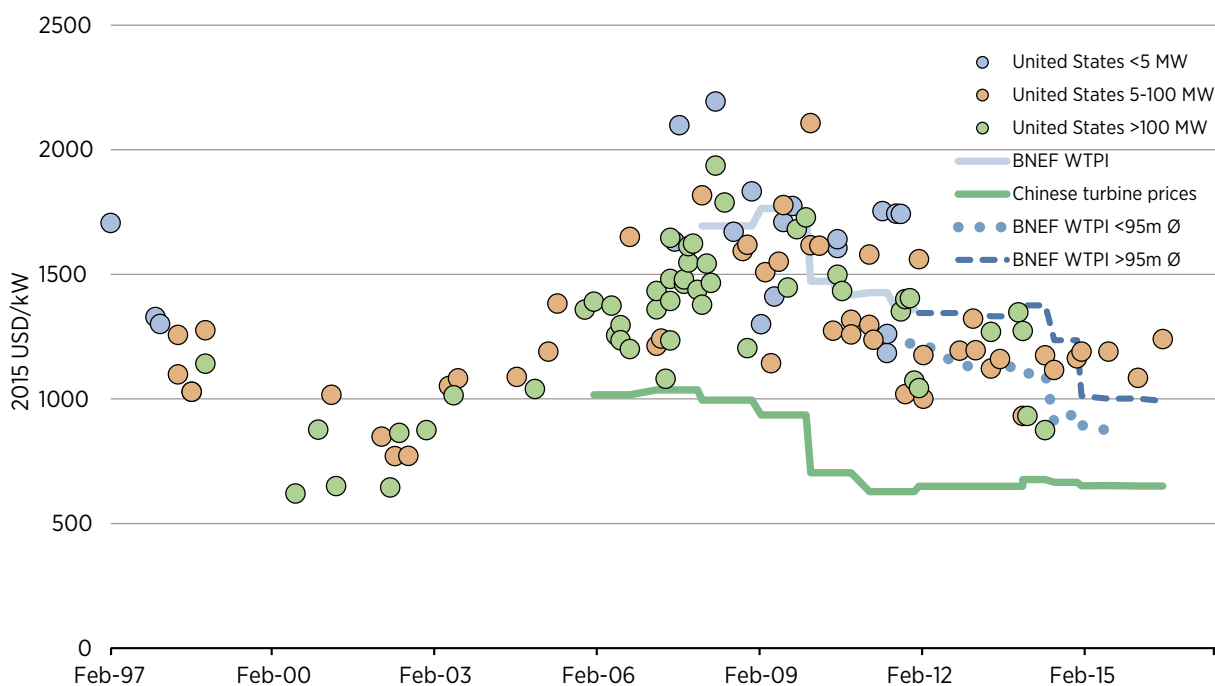
## Wind turbine costs

Wind turbine prices can fluctuate with economic cycles and commodities prices, such as steel and copper, which make up a significant part of the cost of wind turbines. Between 2000 and 2002, turbine prices for onshore wind farms in the United States

reached a low of around USD 750/kW (Wiser and Bollinger, 2015), but average prices had risen to above USD 1 500/kW by 2008 (with a number of contracts at USD 1 800/kW) (Figure 17). This increase was due to the rising cost of materials such as steel and cement. Other factors pushing up costs were the inflation in civil engineering costs, high profit margins for wind turbine manufacturers and larger turbines. The latter can cost more – notably for towers and foundations – but achieve higher capacity factors.

Wind turbine prices have seen a marked decrease since peak prices in 2008 and 2009. Preliminary estimates for projects in 2016 suggest prices between USD 950 and USD 1 240/kW, implying cost reductions of around 30-40% depending on the project size. The BNEF wind turbine index for wind turbines with less than 95 m diameter decreased by 36% and the wind turbine index for wind turbines with rotors larger than 95 m decreased by 27% over the period 2008-2009 to 2015 (Figure 17). The trend of decreased turbine prices is likely to continue in the coming years and is likely to spur more industry consolidation, such as the recent Nordex-Acciona merger. Other factors affecting falling prices include portfolio optimisation and platform-based production (MAKE Consulting, 2015a), reduced

FIGURE 17: WIND TURBINE PRICES IN THE UNITED STATES, CHINA AND THE BNEF WIND TURBINE PRICE INDEX, 1997-2016



Source: Wiser and Bollinger, 2015; CWEA, 2013; BNEF, 2016a; GlobalData, 2014

commodities prices, and increased competition from Chinese manufacturers. The impact of Chinese manufacturers in established markets has been relatively modest since 2010 when the first contract was signed in which Chinese wind turbines

would be used in the European market. However, with an increased focus on export markets, Chinese manufacturers could exert significant downward pressure on prices in the future.

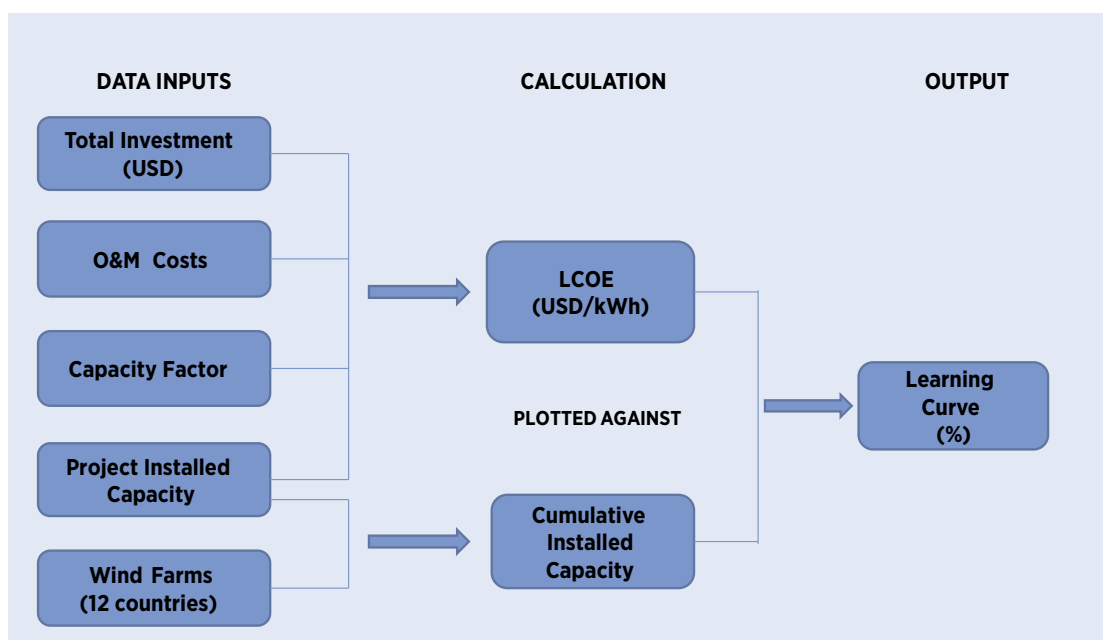
### BOX 3

#### IRENA's analysis of the onshore wind power learning curve

IRENA has updated the learning curves for the installed costs and the LCOE of onshore wind to reflect the significant cost and technology changes, as well as growth in installation of onshore wind worldwide, in the last 10 years. IRENA has analysed the learning curve as the relation between the cost metric and cumulative production in line with a range of earlier analyses (Junginger, *et al.*; 2010). The analysis for onshore wind brings the learning curve analysis up to date by including the period of rapid growth in deployment and installed cost increases and then declines since 2008/09, as well as technology improvements. To arrive at the estimates, IRENA used a dataset of the costs and performance of more than 3 200 individual onshore wind farms within a panel of 12 countries (Brazil, Canada, China, Denmark, France, Germany, India, Italy, Spain, Sweden, the United Kingdom and the United States) that accounted for 87% of installed capacity at the end of 2014. The individual projects account for 157 GW of installed capacity and span the period 1992-2014 (47% of cumulative global capacity at the end of 2014), with data gaps filled by data from academic, industry and government sources.

Data on annual capacity additions, installed costs and capacity factors are robust and comprehensive. However, data on O&M costs have been less systematically reported, and significant gaps exist. This has a relatively modest impact on the early years of the time series, but becomes a more significant uncertainty as LCOEs declined into the sub-USD 0.1/kWh range and O&M costs started to make up a more significant proportion of total electricity costs. The situation is worse for cost of capital data, which simply do not exist or are the result of anecdotal reporting. As a result, the analysis is performed with a fixed WACC over the entire period. Future analysis by IRENA will include a sensitivity analysis that looks at different hypothetical WACC cost reductions that may have occurred as the technology and market risk premiums for onshore wind fell as the technology matured.

FIGURE 18: ONSHORE WIND LEARNING CURVE ANALYSIS DATA REQUIREMENTS



Source: IRENA



## Total installed costs

Figure 19 shows the total installed costs (annual weighted averages or individual project data) of onshore wind farms for the 12 different countries examined in the IRENA learning curve analysis.<sup>24</sup> On average, a doubling of the cumulative installed capacity of onshore wind between 1983 and 2014 resulted in a 7% reduction in weighted average installed costs.

Globally, the installed costs of onshore wind have seen a significant decline since the early 1980s. Global weighted average installed costs declined from USD 4 766/kW in 1983 to USD 1 623/kW in 2014, translating into an overall reduction of two-thirds between 1983 and 2014. Preliminary data

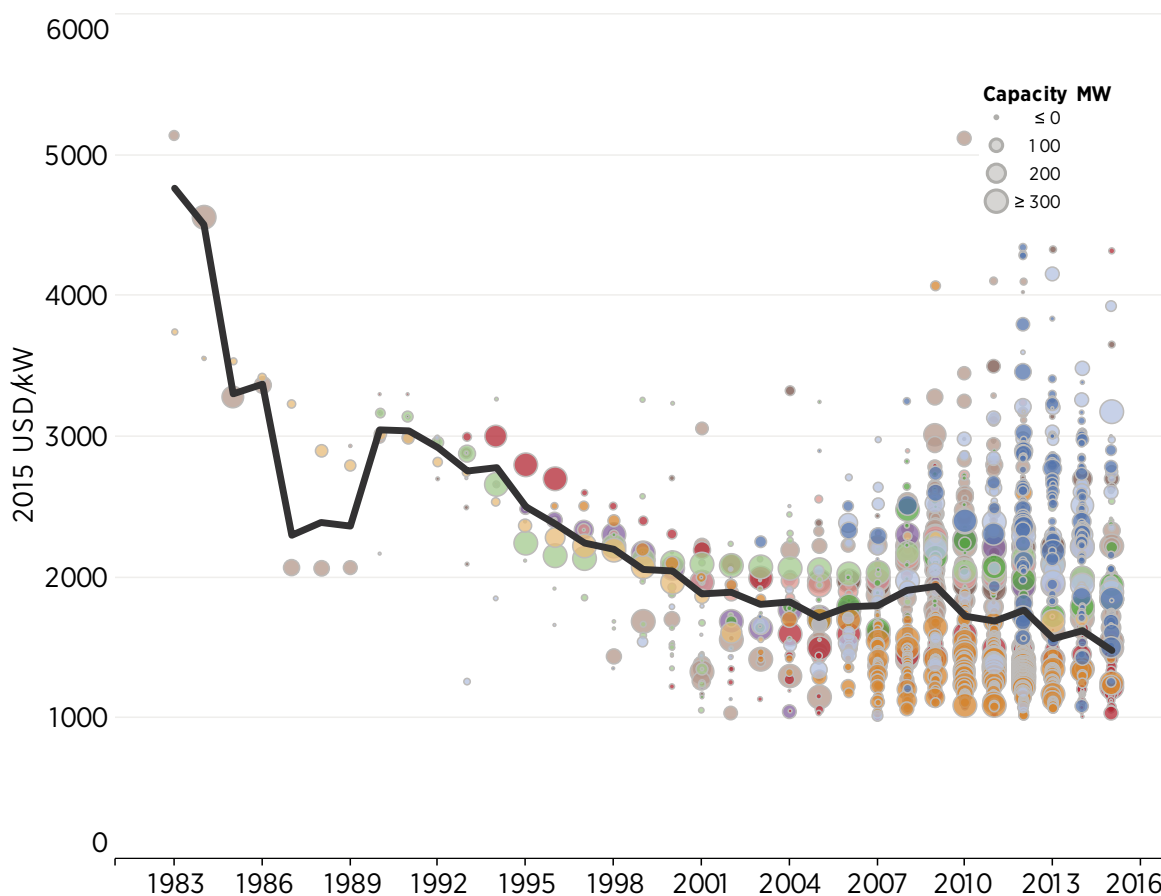
<sup>24</sup> Brazil, Canada, China, Denmark, France, Germany, India, Italy, Spain, Sweden, the United Kingdom and the United States.

for 2015 suggest that the global weighted average installed cost of onshore wind may have fallen to around USD 1 560/kW. To take a specific country example, in the United States – an early adopter of wind power – the installed costs decreased from over USD 5 000/kW in 1983 to USD 1 707/kW in 2014 (Wiser and Bollinger, 2015).

The impact of the increase in turbine prices between 2002 and 2008/2009 is clearly visible, but less pronounced (Figure 19). This is due to the balance of project costs reducing the percentage increase and to China and India emerging as significant players with lower cost structures than other regions.

Total installed cost ranges by country are quite wide (Figure 19 and IRENA, 2015). They are also not uniformly distributed. China and India, in

**FIGURE 19: TOTAL INSTALLED COSTS OF ONSHORE WIND PROJECTS BY COUNTRY, 1983-2014**



Source: IRENA Renewable Cost Database.

Note: Each circle represents an individual project, or for data prior to 2000, country averages (with some country exceptions). The centre of the circle is the installed cost value and the diameter is the size of the annual installations prior to 2000, or the individual project size. Given the IRENA Renewable Cost Database has proportionately more project data for the period 2006-14, the apparent increase in spread of costs is not statistically significant.

particular, have significantly lower average installed costs. Indeed, average costs in China were the lowest in the world in 2014 and 2015, at around USD 1 270/kW. India rivalled China in low installed costs, which averaged around USD 1 325/kW.<sup>25</sup> Outside these two countries, average installed costs are higher and their ranges wider. This is because other countries and regions do not benefit from the low local commodity prices, low-cost labour and manufacturing bases available in China and India and projects are more diverse in nature.

A key driver of cost reduction has been the growth in economies of scale that have been experienced as the market has grown from 6.6 GW of new installations globally in 2001 to 59.5 GW in 2015. Other drivers include greater competition among suppliers and technological innovation. The latter has driven costs down and through higher rated turbines, hub heights and rotor diameters that have increased yields from the same or lower wind resource. Additionally, improved logistical chains and streamlined administrative procedures contributed to the observed cost declines.

## Capacity factors

Higher hub heights and larger swept areas, due to larger rotor diameters, have played a key role in increasing the average capacity factors of wind farms (Figure 20) and smoothing their output (Hirth & Müller, 2016). This is despite the fact that in some markets there is an increased share of lower quality wind sites being developed than previously.

Global average capacity factors grew significantly between 1983 and 2014, rising from an estimated 20% in 1983 to 27% in 2014 (a 35% increase). Capacity factors vary significantly by region, driven predominantly by resource quality. Higher hub heights and rotor diameters account for the vast increase in capacity factors observed over the 32

<sup>25</sup> In India, part of the reason for the low installed costs is that the country is often characterised by so-called “soft winds” that are quite constant but not very strong. In these wind regimes, smaller, cheaper turbines offer the pathway to the lowest LCOE. This also implies that turbine size and swept area growth rates are likely to grow more slowly in India than in other markets.

years.<sup>26</sup> Additionally, improvements in wind farm development (e.g., better micro-siting of turbines based on more detailed wind resource analysis) and improved wind turbine reliability have helped increase the capacity factors of onshore wind worldwide.

Figure 21 highlights the weighted average national capacity factors for new projects that were installed in 2000 and 2014 in different countries. Average capacity factors in the United States in the year 2000 were around 31%, while for new capacity added in 2014 they had risen to around 35%, but spanned a wide range (18-54%) (Wiser and Bollinger, 2015). Weighted average project capacity factors in China were around 24% in 2014, but above 45% in Brazil. In China, grid constraints have resulted in significant curtailment and the dispatched generation average capacity factor is closer to 20%. The advances in technology that have resulted in turbines optimised for low wind speed conditions have allowed developers to exploit lower resource wind sites that were previously uneconomical. With the current increase in capacity factors due to better technology, the economics of such low-wind sites has changed fundamentally.

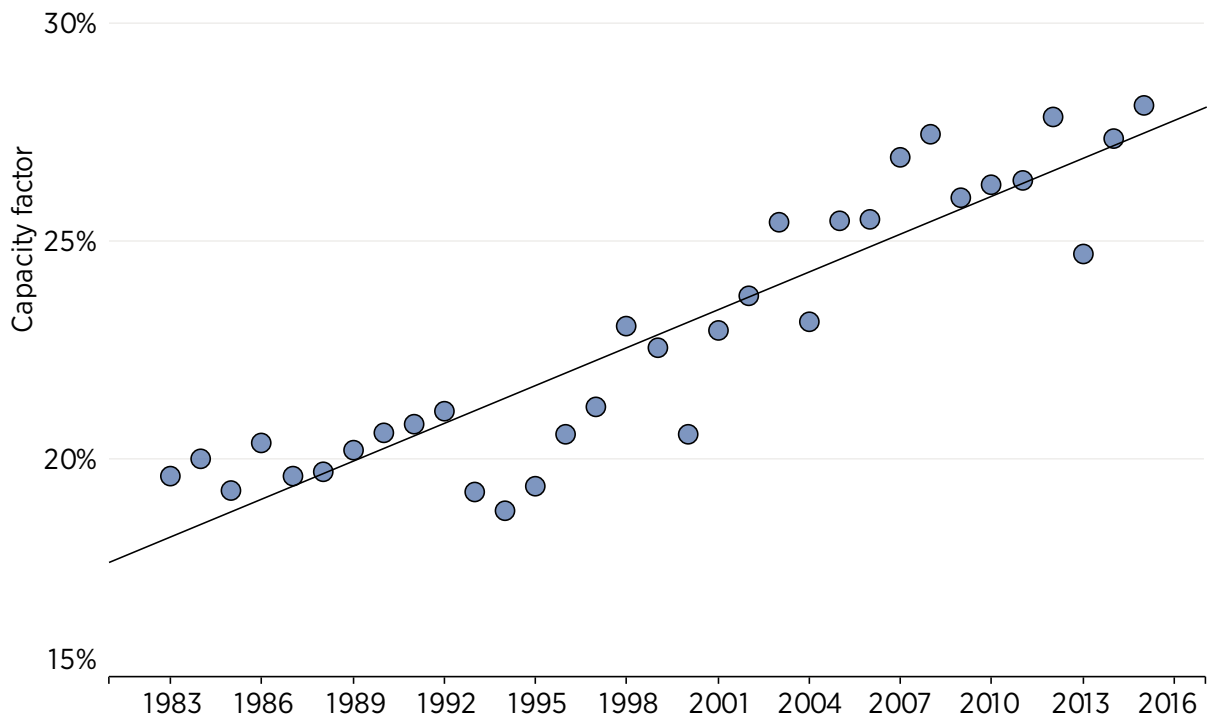
## Operations and maintenance costs

Fixed and variable O&M costs are a significant part of the overall LCOE of wind power. O&M costs can account for 20-25% of the total LCOE of wind power systems in Europe (EWEA, 2009). Data for actual O&M costs from commissioned projects are not widely available. Indeed, even where data are available, care must be taken in extrapolating from historical O&M costs, given the dramatic changes that have occurred in wind turbine technology over the last two decades.

Another issue is that although data for maintenance costs are sometimes available, the cost data for operations – such as management costs, fees, insurance, land lease payments and local taxes –

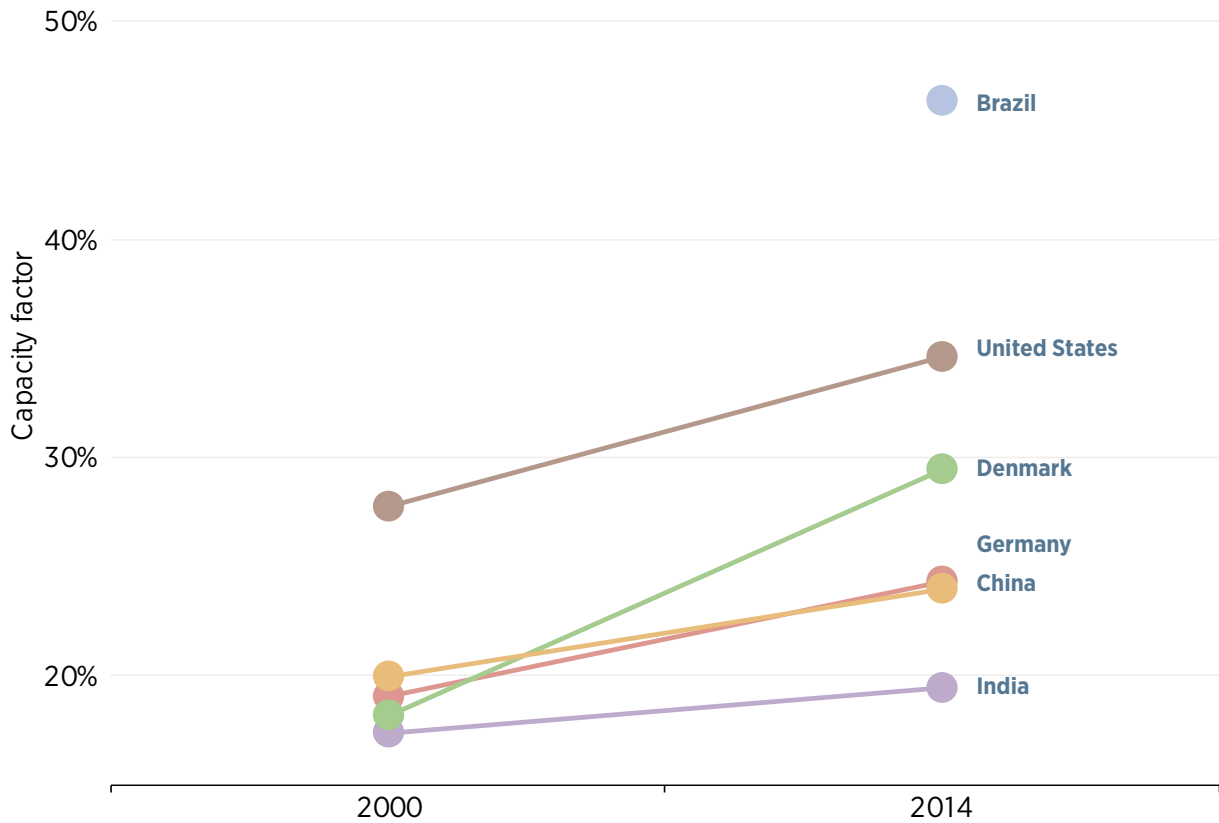
<sup>26</sup> Although new markets are emerging with higher average capacity factors than the mature wind power markets, the dominance of existing markets (notably China) in total new capacity installations means their impact on the global weighted average capacity factor remains modest for the moment.

FIGURE 20: GLOBAL WEIGHTED AVERAGE CAPACITY FACTORS FOR NEW ONSHORE WIND POWER CAPACITY ADDITIONS, 1983-2014



Source: IRENA Renewable Cost Database.

FIGURE 21: COUNTRY-SPECIFIC WEIGHTED AVERAGE CAPACITY FACTORS FOR NEW CAPACITY, 2000 AND 2014



Source: IRENA Renewable Cost Database and Wisser and Bollinger, 2015.

are not systematically collected. As a result, good data on total O&M costs are not typically available.

However, given these caveats, it is clear that the annual average O&M costs of wind power systems have declined substantially since 1983. BNEF (2016b) data for the maintenance costs for onshore wind concluded that between 2008 and the first half of 2015, full-service maintenance contract prices fell by 27%. Total O&M costs reported by publicly traded developers in the United States were around USD 0.024/kWh in 2013. With a slightly different data sample, the reported O&M costs in the United States for new capacity added of around USD 0.01/kWh (Wiser and Bollinger, 2014) suggests a very different cost structure for the latest wind projects, but the true average will likely be higher as maintenance costs rise over the life of the project. In Europe, a survey of more than 5 000 wind turbines installed since 2006 in Denmark has shown that with higher rated turbines, O&M costs have declined from 3% of CAPEX per year to 1.5-2% of CAPEX (Manwell *et al.*, 2009).

Table 5 presents data for the O&M costs reported for a range of OECD countries. Data are not consistently reported and comparisons are made more difficult by uncertainty about whether the same boundaries are applied to O&M costs. An average value of around USD 0.02 to USD 0.03/kWh would appear to be the norm, but the

data are far from comprehensive or conclusive. In non-OECD countries O&M costs are lower and assumed to be USD 0.01/kWh (IRENA, 2015).

Most developers prefer their first O&M contracts, typically from the turbine manufacturer, to last three to five years so that they benefit from future cost reductions in O&M prices or create the in-house O&M capabilities in order to better control O&M costs (MAKE Consulting, 2015a).

## Levelised cost of electricity

The LCOE of a wind power project is determined by total capital costs, wind resource quality, the technical characteristics of the wind turbines, O&M costs, the economic life of the project and the cost of capital. As with today's range of installed costs, the LCOE also varies by country and region.

Figure 22 presents the LCOE of wind power by region and country in 2014-2015.<sup>27</sup> The weighted average LCOE by country or region ranged from USD 0.053/kWh in China to USD 0.12/kWh in Other Asia. North America had the second lowest

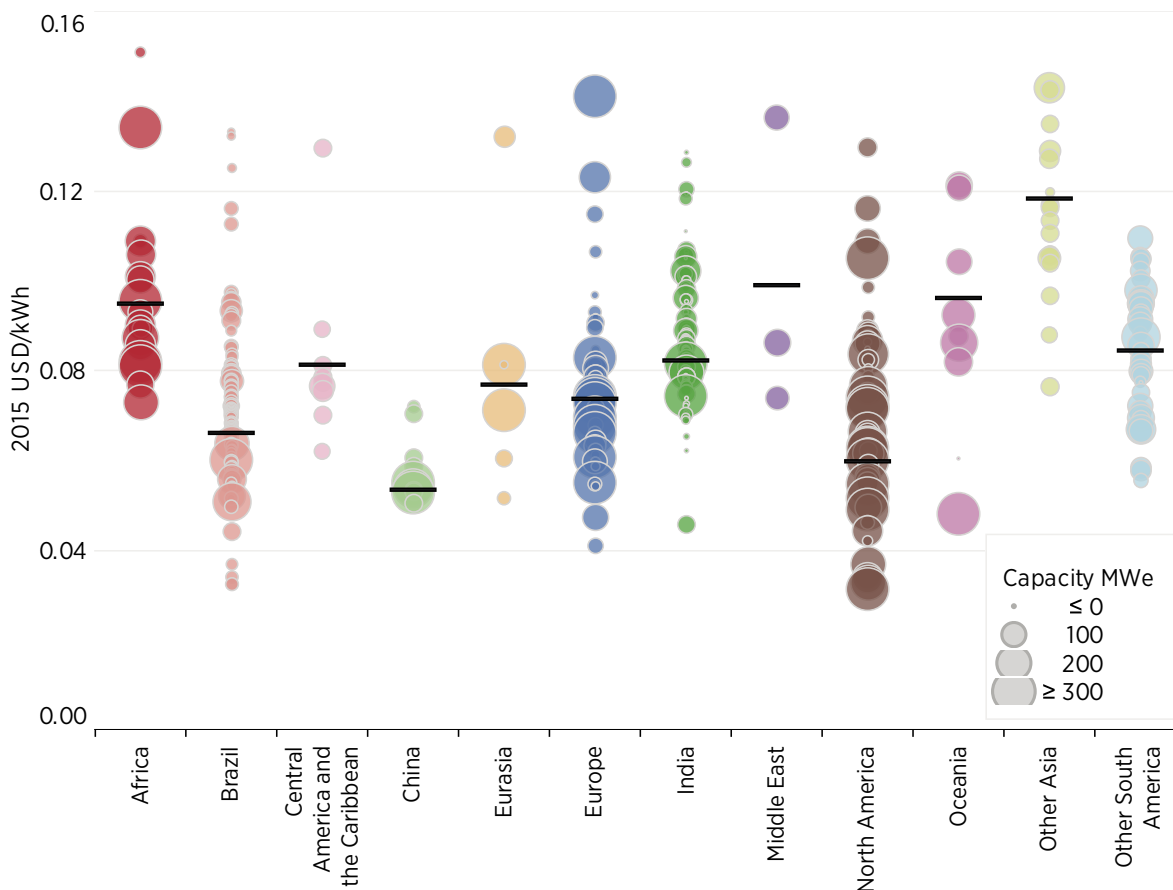
<sup>27</sup> Data for 2015 are already available for the top ten onshore wind markets, but thinner markets are sometimes an average of 2014 and 2015 costs if the current data available for 2015 is not statistically representative. Thus regional data is in some cases a mix of 2014 and 2015 data. Final 2015 data for all markets will be available from [www.irena.org/costs](http://www.irena.org/costs) in July 2016.

**TABLE 5: REPORTED O&M COSTS IN SELECTED OECD COUNTRIES**

	Variable (2015 USD/kWh)	Fixed (2015 USD/kW)
Austria	0.040	
Denmark	0.0161-0.018	
Finland		37-40
Germany		75
Italy		50
Ireland		74
Japan		76
The Netherlands	0.0138-0.0180	
Norway	0.022	
Spain	0.029	
Sweden	0.0106-0.0351	
Switzerland	0.046	

Source: IEA Wind, 2011.

FIGURE 22: LEVELISED COST OF ELECTRICITY FOR ONSHORE WIND FARMS BY PROJECT, AND WEIGHTED AVERAGES BY COUNTRY AND REGION, 2014-2015



Source: IRENA Renewable Cost Database.

LCOE after China, with USD 0.06/kWh. Eurasia (USD 0.08/kWh), Europe (USD 0.07/kWh) and India (USD 0.08/kWh) had slightly higher average LCOEs than China and North America, but exhibited a range of very competitive projects. Lastly, but not far behind, are Central and South America, Oceania and Africa with weighted average LCOEs of between USD 0.08 and USD 0.10/kWh. In 2014 and 2015, the best wind projects delivered electricity at between USD 0.04 and USD 0.05/kWh. Some regions will see significant declines in the weighted average LCOE of newly installed projects in coming years as regional markets gain scale; notably South America where lower-cost Brazilian wind farms will come on line in 2016.

## COST REDUCTION POTENTIALS TO 2025

Despite the substantial cost reductions that have occurred since the deployment of wind power on

a commercial scale in the early 1980s, onshore wind still holds significant cost reduction potential for the period out to 2025. IRENA has assessed the cost reduction potential for onshore wind from a top-down and bottom-up perspective. The top-down analysis is based on a learning curve analysis, while the bottom-up analysis looked at trends in wind turbine technologies and wind farm development to estimate the shift to higher performance turbines in different markets and cost implications of new technology innovations. Estimates of the contribution of increased market scale and maturity are harder to assess, but have been estimated based on trends in turbine pricing and analysis by consultants of supply chain efficiencies. In terms of deployment, the next doubling of onshore wind is likely to occur between 2020 and 2022, depending on deployment rates. Accelerated deployment in the IRENA REmap 2030 analysis (IRENA, 2016a), however, suggests that under an aggressive deployment scenario, a

doubling from 2014 values could occur as soon as 2019.

The key directions in technological innovation (MAKE Consulting, 2015b) that will allow for the reduction of the LCOE of onshore wind out to 2025 are the following:

- » Larger turbines: The continued trend towards larger turbines will have a small but important impact in lowering installed costs through economies of scale, as well as reducing per-kilowatt wind farm development costs (KIC InnoEnergy, 2014a and Serrano-González & Lacal-Arántegui, 2016). But may be cost-neutral in some markets due to offsetting cost increases for towers and foundations if not accompanied by light-weighting.
- » Advanced blades: These will have a modest impact on reducing installed costs, but can raise electricity output.
- » Advanced towers: These can reduce installed costs, relative to conventional steel towers, in order to access higher average wind speeds or “smoother” winds at greater heights.
- » Improved turbine reliability and O&M best practices: These can reduce turbine downtime and raise electricity yields, while reducing maintenance costs from unscheduled malfunctions.
- » Lean supply chains and increased competition: This will help reduce installed costs by ensuring the most competitive supply chains are maintained.
- » Wind farm best practices: These can reduce development and installation costs by using industry best practices more widely (RenewableUK, 2015).<sup>28</sup>

There will be significant variations in the cost reduction potential depending on the market.

<sup>28</sup> This is applicable not just from a wind farm developer perspective, but also from a regulatory standpoint. For instance, streamlined and efficient project approval processes pioneered by more mature markets could be introduced early to emerging wind markets.

More competitive markets using today's latest technologies are going to benefit from incremental technological improvements and greater economies of scale, as well as competitive pressures. Yet they will not see as large cost reduction potentials as in markets where there is more scope for cost reductions due to inefficient supply chains, lack of competition and other factors. However, it is worth noting that the markets with the lowest cost reduction potential are also often markets with very competitive costs today relative to other new power generation capacity options.

## TOTAL INSTALLED COST REDUCTION POTENTIAL

The total installed cost reduction potential remains significant for many markets, although markets with very competitive cost structures, such as China and India, or restrictive policies, will experience lower than average cost reductions. Those with less competitive costs structures, such as new markets in Latin America and Africa, or with increasing competitive pressures, will experience above average cost reductions. Out to 2025, the global weighted average total installed costs of onshore wind farms could fall by around 12% and account for 34% of the total LCOE cost reduction potential. In order of importance, the key areas for installed cost reduction are: larger turbines, advanced towers, increased application of best practice in wind farm development, lean supply chains and advanced blades (MAKE Consulting, 2015b and KIC InnoEnergy, 2014).

### Wind turbines

There remain cost reduction potentials for wind turbines from the turbine and nacelle components, as well as from towers and blades. At the same time, increased supply chain optimisation and competition could drive down costs with the right policy settings.<sup>29</sup> The application of best practices

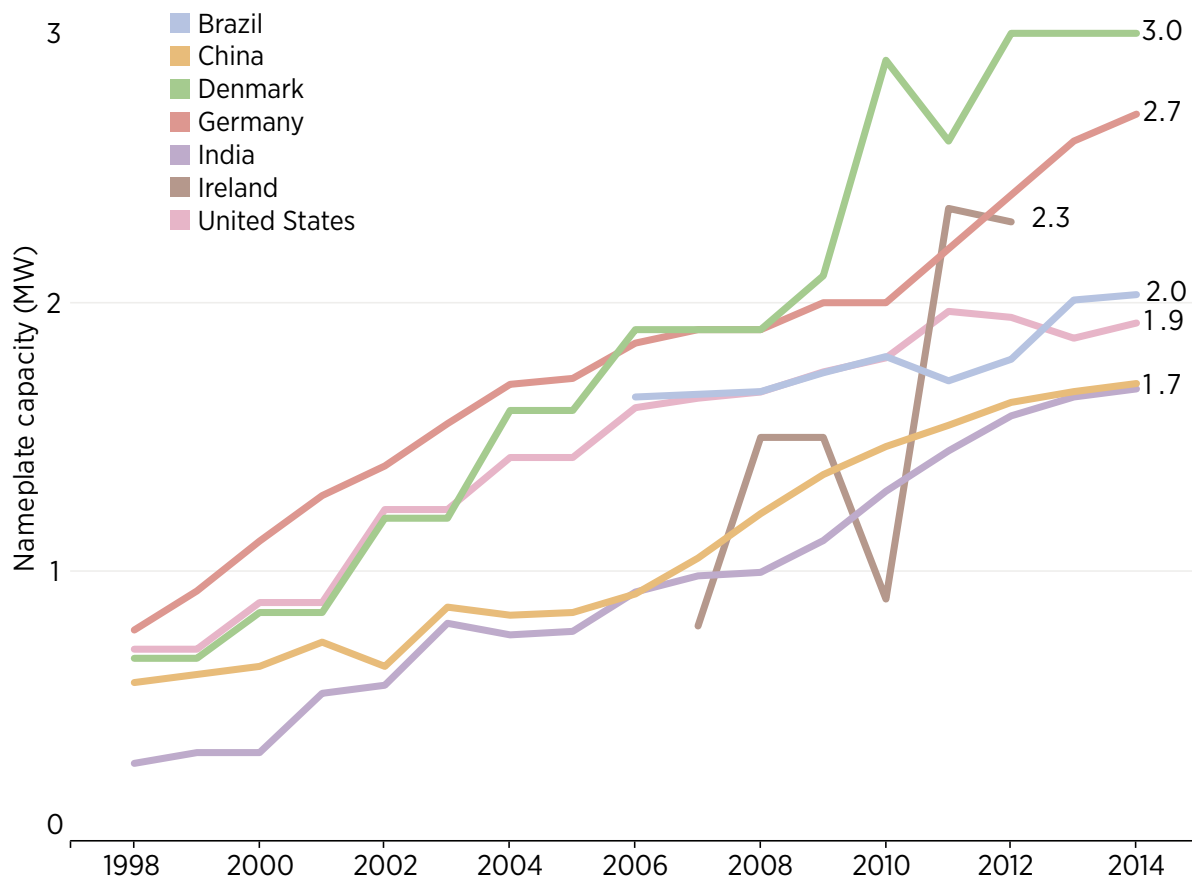
<sup>29</sup> Policy stability is also critical for investor confidence and the absence of stable policy, or retrospective changes to support schemes, are the largest determinant of risk and hence cost of capital after country risk in Europe (Angelopoulos *et al.*, 2016).

in wind farm development can also help to reduce installed costs (RenewableUK, 2015).

Average blade lengths are growing, rapidly in some markets, as the trend to larger turbines and greater swept area drives increased electricity yields. Reducing the transportation and installation costs of these larger blades, now approaching 70 m in length, is becoming a priority. This could drive a trend towards segmented blades. Weight is also becoming an issue for these larger blades and manufacturers are investigating innovative manufacturing techniques to reduce installed costs. These include reducing fibre misalignment, using advanced materials such as high-performance glass fibre, redesigning the blade roots and looking at more slender airfoils (also for energy yield increases) and structural load management strategies to reduce blade weights while maintaining structural integrity (MAKE Consulting, 2015a).

The trend towards higher-rated turbines (Figure 23) – particularly the 3 MW platforms offered by most manufacturers outside of China and India – presents manufacturers with the opportunity to introduce further innovations. These include hybrid drivetrains, unique structural architecture and different yaw and pitch system arrangements on a range of semi-standardised platforms optimised for different wind environments (MAKE Consulting, 2015a). These can deliver installed cost savings and allow greater optimisation of turbines to the local market and its siting and resource needs (MAKE Consulting, 2015a and KIC InnoEnergy, 2014a). Standardised turbine platforms for onshore wind turbines offer economies of scale, commonality of a significant share of components (MAKE Consulting, 2015a) and the spreading of development costs over a wider product line. An increased range of offerings based on standardised platforms has seen manufacturers recently expand their portfolio

FIGURE 23: WEIGHTED AVERAGE NAMEPLATE TURBINE CAPACITY BY COUNTRY, 1998-2014



Source: Wiser and Bollinger, 2015; GlobalData, 2016; DEA, 2016; IEA Wind, 2015.

of offerings beyond single digits. General Electric, Siemens and Vestas have all roughly doubled the number of offerings in their portfolio since 2010, with each now offering over 20 models. Utilising the same structural components across a given platform can mean up to 50% of the turbine components are identical, significantly reducing development costs and unlocking supply chain efficiencies (MAKE Consulting, 2015a).

There are additional economies of scale that can be unlocked at the manufacturing level. Individual wind turbine manufacturers are relatively small compared to the global market and lack the economies of scale seen in some other industries. Goldwind accounted for the largest share of new turbines installed in 2015, yet only accounted for 13.5% of the market (BNEF, 2016c). Only three manufacturers – Goldwind, Vestas and General Electric – installed more than 5 GW each of the more than 59 GW new capacity installed in 2015. Growth in new capacity additions and consolidation in the turbine manufacturing sector may help to achieve greater economies of scale in manufacturing, although whether these savings are passed on to customers depends on competition remaining strong. Recent consolidations within the sector are evidence that some wind turbine producers are using mergers to try and unlock potential efficiencies and improve their market positioning.

Increased consolidation in turbine manufacturing, along with increased standardisation in turbine platforms by manufacturers, will help realise some of the potential gains that can be unlocked in supply chain efficiency. At the same time, competitive pressures will see more finely tuned supply chains delivering cost savings. The growth of some regional markets may also unlock opportunities to optimise manufacturing close to demand.<sup>30</sup>

Towers typically represent the largest component of turbine costs. This is because they use significant amounts of materials to support the turbine and the loads that the turbine operation induces on the tower and which are transmitted

to the foundations. Advanced, taller towers are an important part of future electricity cost reduction potential by unlocking greater wind resources at higher heights and areas with good wind resources, but otherwise unsuitable for shorter, conventional towers (e.g., forested areas needing higher height clearance). Although taller towers typically cost more, due to the necessity of supporting increased loads, efforts to reduce the materials used for towers while maintaining the same structural limits can help reduce installed costs. General Electric's space frame tower, Siemens' bolted shell tower and Vestas' large diameter steel towers are designed to reduce logistics costs and the challenges of tall towers, while avoiding the need to use expensive concrete towers. By increasing the base diameter, these innovations allow reduced thickness for the same load and reduced material costs relative to conventional steel towers.

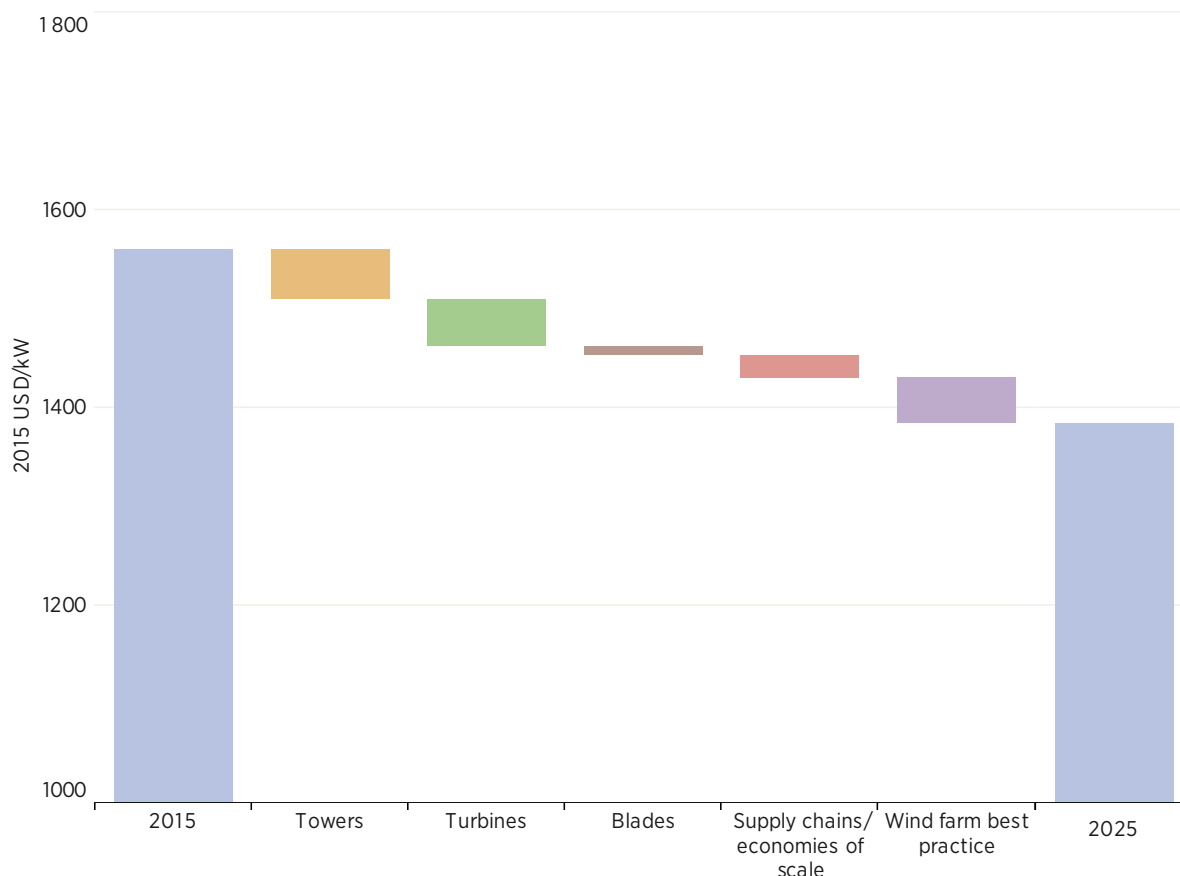
Overall cost reductions for the global weighted average installed cost could average around 12% between 2015 and 2025, taking into account the trend towards larger turbines, with higher hub heights and larger swept areas. This bottom-up estimate is within the range of the learning rate of 7% for total installed costs identified by updated onshore wind learning curve and the IRENA REmap projections to 2030 (IRENA, 2016a).

Turbines and towers account for the largest share of the installed cost reduction potential to 2025 (Figure 24). These account for 27% and 29%, respectively of the total reduction in the global weighted average installed cost of onshore wind farms (IRENA analysis and MAKE Consulting, 2015b). Yet, the increased application of best practices in wind farm development by project developers and regulators could yield around one-quarter of the total cost reduction. Best practices include streamlined project approval procedures and nationally agreed evaluation criteria for local consultation. Supply chain and manufacturing economies of scale account for around 13% of the total cost reductions and advanced blades for the balance. Overall, the global weighted average total installed cost for onshore wind could fall from around USD 1 560/kW in 2015 to USD 1 370/kW in 2025 (Figure 24).

<sup>30</sup> This should not be used as an opportunity to introduce restrictive local content policies. There will, however, be opportunities to support local content production where there are realistic opportunities to achieve cost equivalency with internationally sourced components.



FIGURE 24: TOTAL INSTALLED COST REDUCTIONS FOR ONSHORE WIND FARMS BY SOURCE, 2015-2025



Source: IRENA analysis and MAKE Consulting, 2015b.

## CAPACITY FACTORS

As has already been highlighted, the growth in global weighted average capacity factors has been driven by improvements in turbine technology; including larger turbines, more efficient blades, higher hub-heights (accessing better wind resources) and larger swept areas.

Larger rotor diameters increase the swept area of wind turbines, which has a linear positive relationship with energy capture. Thus, the energy capture of the respective wind turbine increases for the same wind resource, driving upwards the capacity factors. An additional advantage is that wind turbines with larger swept areas tend to have more constant wind output, helping to smooth output variability to a certain extent (Hirth & Müller, 2016). Just how significant the technology impact can be is highlighted in the presentation of the modelled capacity factors for turbines from

two manufacturers in different wind classes – approximating wind quality (Figure 25).

The ongoing trend to larger turbines has meant that between 1998 and 2014, the weighted average nameplate capacity increased by 2.4 times in Germany, 3.4 times in Denmark, 1.7 times in the United States, 1.9 times in China and 4.8 times in India (Figure 23). Regionally, in 2015, weighted average turbine ratings were 1.6 MW in the Asia-Pacific, 1.9 MW in the Americas, and 2.5 MW in Europe, Middle East and Africa (MAKE Consulting, 2015b). By 2025, weighted average nameplate capacity is expected to reach 2.2 MW in Asia-Pacific, 2.7 MW in the Americas and 3 MW in Europe, Middle-East and Africa (IRENA and MAKE Consulting, 2015b). By country in 2025, the weighted average nameplate capacity for newly installed capacity is forecast to be 3.6 MW in Denmark, 3.5 MW in Germany, 2.6 MW in the United States, 2.4 MW in India and 2.5 MW in China. The forecasts contain a degree of

uncertainty, however, since they are made for a period of more than ten years and depend, amongst other factors, on the geographic distribution of deployment within these countries.

Comprehensive data on the evolution of rotor diameters exists for a range of countries and this data shows that weighted average rotor diameters increased significantly from 1998-2014 in a range of countries (Figure 25). In Germany, rotor diameters increased from 48 m in 1998 to 99 m in 2014. In Denmark, they increased from 45 m to 104 m, while in the United States, they rose from 48 m to 99 m. Rotor diameters are estimated to reach 125 m in Denmark, 119 m in the United States and 120 m in Germany by 2025 (Figure 26). Depending on technological innovation and developers' choices, the final numbers might be lower or slightly higher.

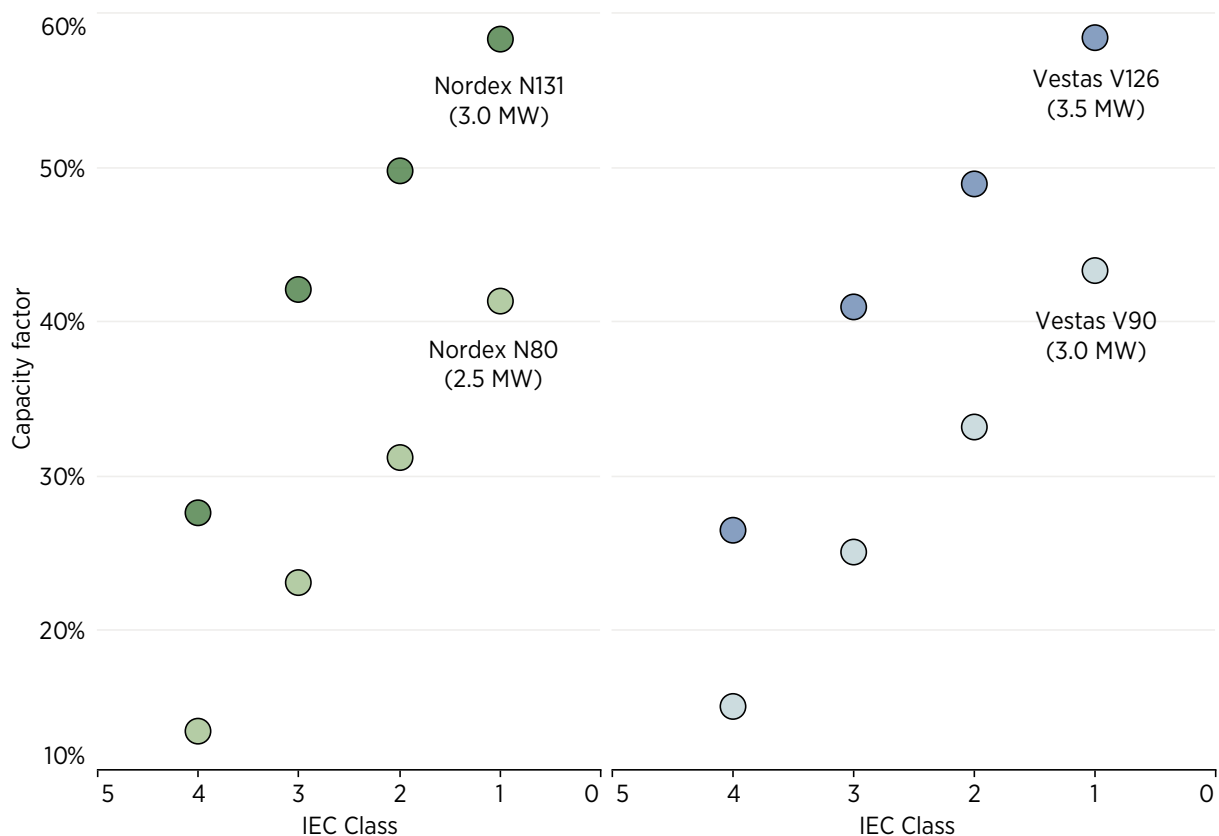
Wind turbine hub heights have also increased in recent decades and this trend is projected to

continue. From 1998-2014, hub heights increased by 80% in Germany, 110% in Denmark and 49% in the United States (Wiser and Bollinger, 2015; DEA, 2016; and IEA Wind, 2015). Higher hub heights allows developers to access better wind resources<sup>31</sup> and exploit rougher terrains in countries where land constraints are an issue, such as in densely populated Europe. This allows developers to exploit sites previously uneconomical due to location or low-wind conditions. However, higher hub heights can raise tower and foundation costs. In recent years, this cost escalation has been relatively modest as light-weighting of the nacelle and components has helped reduce any impact (IRENA, 2012).

In addition to these technology drivers, improved micro-siting of turbines from improvements in resource measurement and modelling will also help

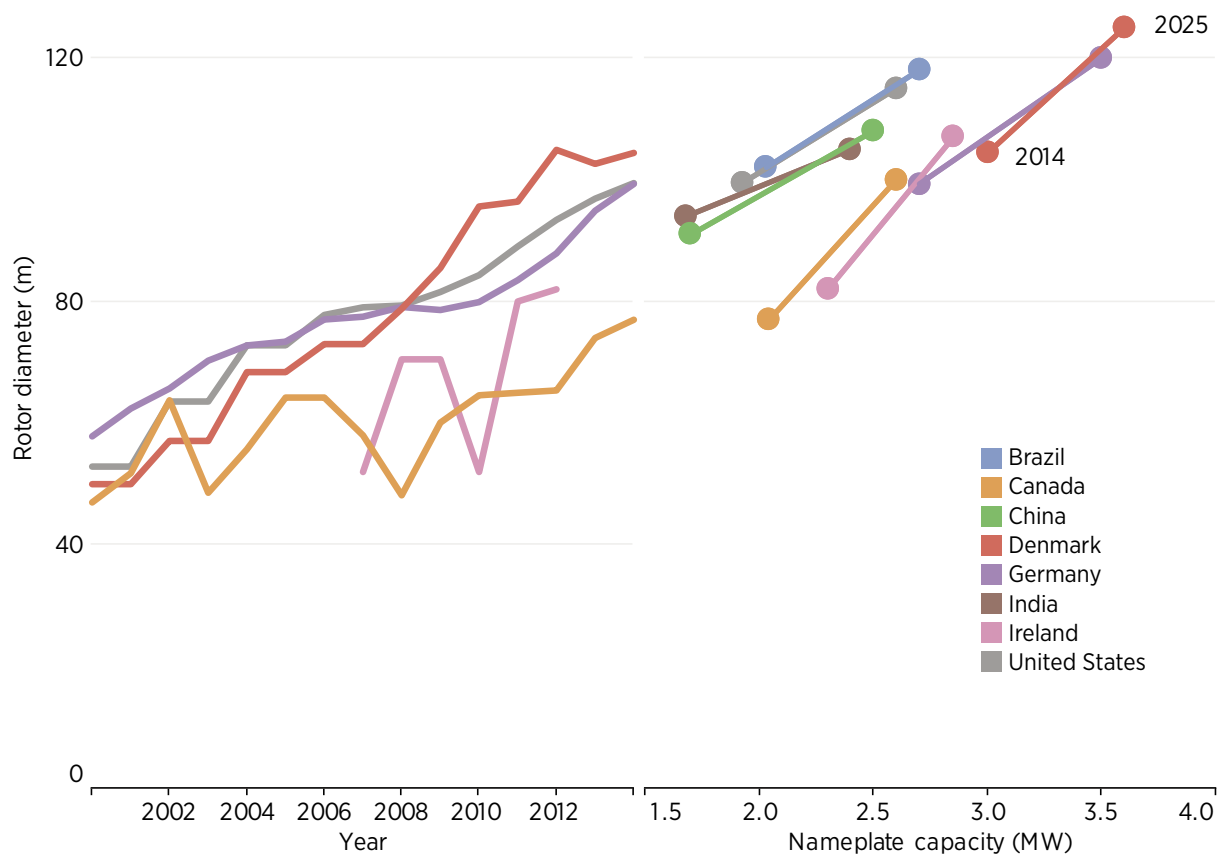
<sup>31</sup> Output increases roughly proportionately with the square root of hub height, depending on the roughness of the surrounding terrain (EWEA, 2009).

FIGURE 25: CAPACITY FACTORS BY IEC WIND CLASS FOR NORDEX AND VESTAS WIND TURBINES



Source: Staffel, 2012 and IRENA analysis based on manufacturers power curves.

FIGURE 26: TRENDS IN ONSHORE WIND ROTOR DIAMETER AND TURBINE SIZE BY COUNTRY, 2000-2025



Source: IRENA analysis, Wisser and Bollinger, 2015; GlobalData, 2016; CanWEA, 2016; DEA, 2016.

improve capacity factors (KIC InnoEnergy, 2014a). Also helping will be innovative solutions for yaw and pitch systems that optimise the turbine orientation and blade angles to the constantly changing wind characteristics facing each turbine.

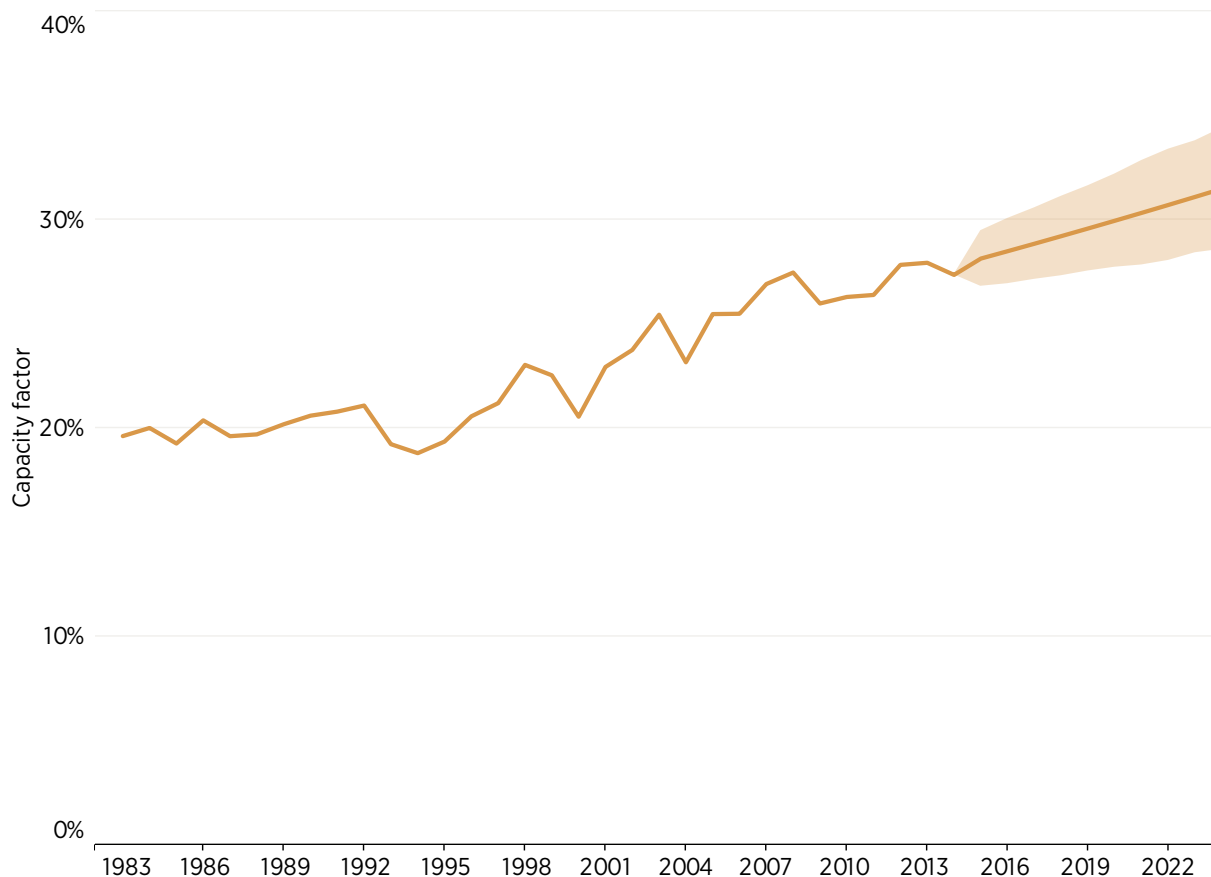
Innovative data management techniques and forecasting software for preventative O&M, combined with weather forecasting software (KIC InnoEnergy, 2014), will allow developers to increase the reliability and operation of wind turbines and to optimise O&M operations. This will help further increase capacity factors by reducing downtime from unplanned maintenance (MAKE Consulting, 2015a). It will also help to reduce O&M costs by reducing expensive, unplanned maintenance interventions.

When combining the trends in the increasing use of today's latest technology, availability increases from improved reliability, as well as new innovations in turbine controls, advanced and more efficient blades, and the improvements in micro-siting

and wind farm development, the global weighted average capacity factor could increase from 27% in 2015 to 32% in 2025 (Figure 27) (IRENA and MAKE Consulting, 2015b). At a global level, the average contribution of increased capacity factors would be to reduce the global weighted average LCOE by around USD 0.01/kWh. However, there are a range of factors that mean the actual weighted average value of the capacity factor in 2025 could be higher or lower (represented by the shaded range in Figure 27). This is due to uncertainty around the rate of increase in hub heights and rotor diameters in key markets, such as India and China, where the rate of adoption of larger machines has a significant impact on the global weighted average. Perhaps the largest uncertainty remains the trends in resource quality for new wind farm developments to 2025.<sup>32</sup>

<sup>32</sup> Note, a lower increase than projected in the global average capacity factor out to 2025 does not represent uncertainty around technology improvements, so much as around the share of different markets and the rate at which they adopt the latest turbine offerings from manufacturers. Much depends on the growth of new markets which are increasingly adopting the latest technologies in excellent wind resource areas.

FIGURE 27: GLOBAL WEIGHTED AVERAGE ONSHORE WIND FARM CAPACITY FACTOR, 1983-2025



Source: IRENA analysis and MAKE Consulting, 2015b.

## OPERATIONS AND MAINTENANCE COSTS

O&M costs typically account for 20-25% of the total LCOE of wind power systems in Europe (EWEA, 2009). Despite the difficulties in identifying solid data on O&M costs, a clear trend of reduced O&M costs with better technology has been documented since 2006 in Denmark (Danish Wind Energy Association, 2006) and for maintenance more generally since 2008 (BNEF, 2016b). As can be expected, both the year of commissioning of a project and the age of a wind farm have an important effect on O&M costs. On average, newer projects exhibit lower O&M costs than older projects, but all projects see a rise in O&M costs over their lifetime, as equipment ages (IRENA, 2015). In many cases, the average O&M costs over the life of the wind farm are not known today, given that turbine technology has changed rapidly over the last 15 years and the bulk of today's installed capacity has operated for less than half of their economic life.

Another complication is that total O&M costs are less clear-cut than for maintenance costs. Projections are thus more speculative, given that actual cost data are extremely difficult to obtain. Yet these costs appear to be trending down, partly due to the increased overall share of emerging markets with lower cost structures. A majority of industry players thus expect O&M costs to reduce in the next two years (MAKE Consulting, 2016b). This is in part expected to come as a result of the increasing competition for O&M contracts, as the share of independent service providers grows.

From an operational and technological perspective, there are two tendencies in terms of O&M strategies that will have an impact on LCOE declines. One is the use of advanced meteorological and fatigue modelling software to forecast wind turbine output and fatigue lifetimes for turbine components, to better manage the servicing of wind turbines. The other is the improved reliability of turbines that is being driven by a focus on minimising O&M costs with

more reliable system configurations and components. These innovations will reduce the downtime of wind turbines and increase electricity output, as well as reduce costly unscheduled maintenance. Combined with more widespread application of best practices in O&M, these trends are set to diminish the overall O&M costs. Globally, improved drivetrain and turbine reliability are expected to yield cost reductions of USD 0.002/kWh, while the wider adoption of best practice O&M strategies could reduce the LCOE by a further USD 0.001/kWh (IRENA and MAKE Consulting, 2015b).

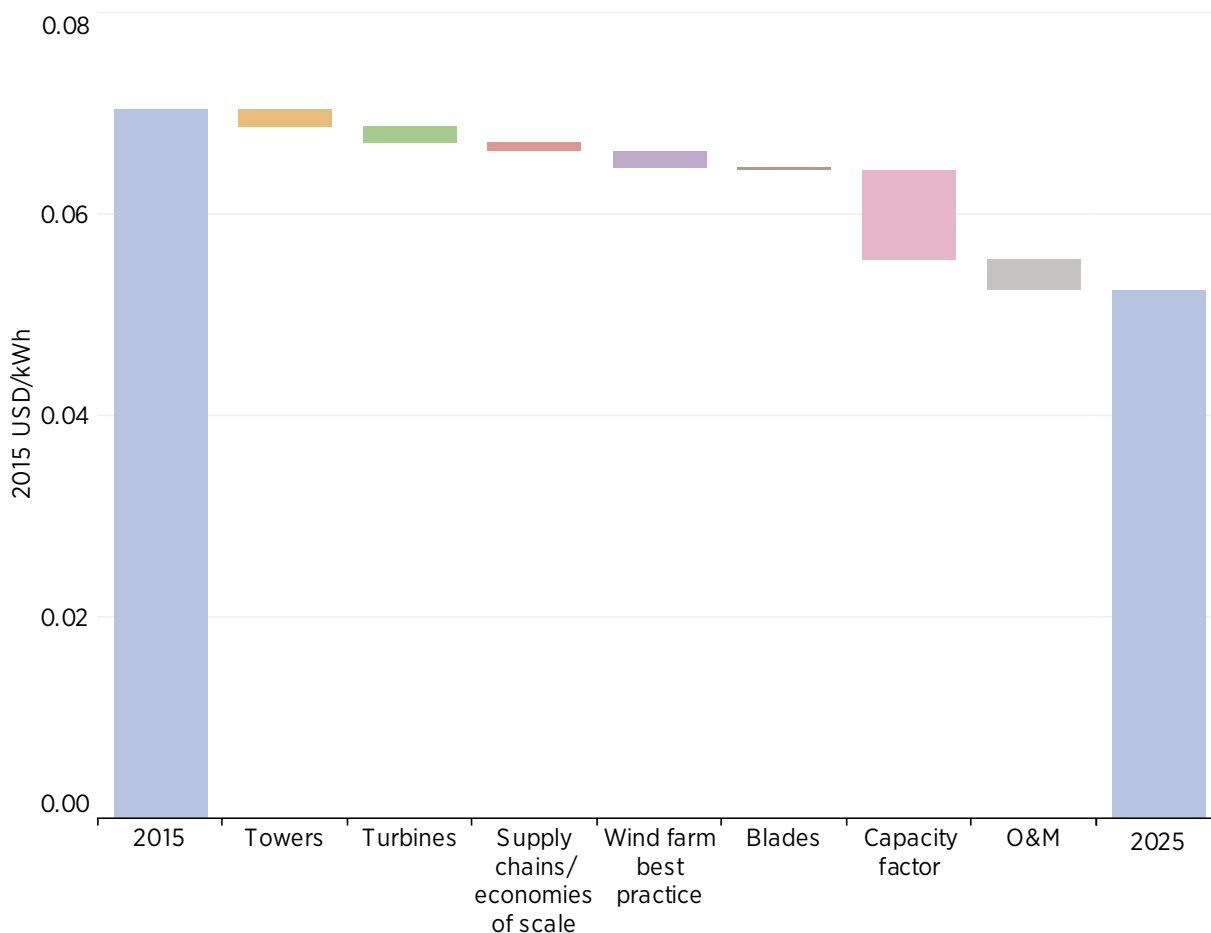
### LEVELISED COST OF ELECTRICITY COST REDUCTION POTENTIAL

Onshore wind is now a highly competitive source of new power generation capacity, with medium- and even low-wind speed sites now economically

viable with recent wind turbine improvements. This has greatly broadened the competitive situation of what is already a modular and versatile power generation technology.

Despite these trends, many markets are yet to fully adopt today's latest technologies. Meanwhile, continued competitive pressures mean manufacturers are continuing to push the envelope in terms of turbine efficiency and design, and cost competitiveness. At the same time, they are also trying to broaden their portfolio of products to better match individual markets. The result is that the global weighted average LCOE of onshore wind could fall by 26% by 2025. This bottom-up analysis is very close to the suggested long-run learning rate for onshore wind (12% cost reduction for every doubling of cumulative installed capacity) and deployment projections from IRENA's REmap analysis (IRENA, 2016a).

FIGURE 28: GLOBAL WEIGHTED AVERAGE ONSHORE WIND LEVELISED COST OF ELECTRICITY REDUCTIONS BY SOURCE, 2015-2025



Source: IRENA analysis.

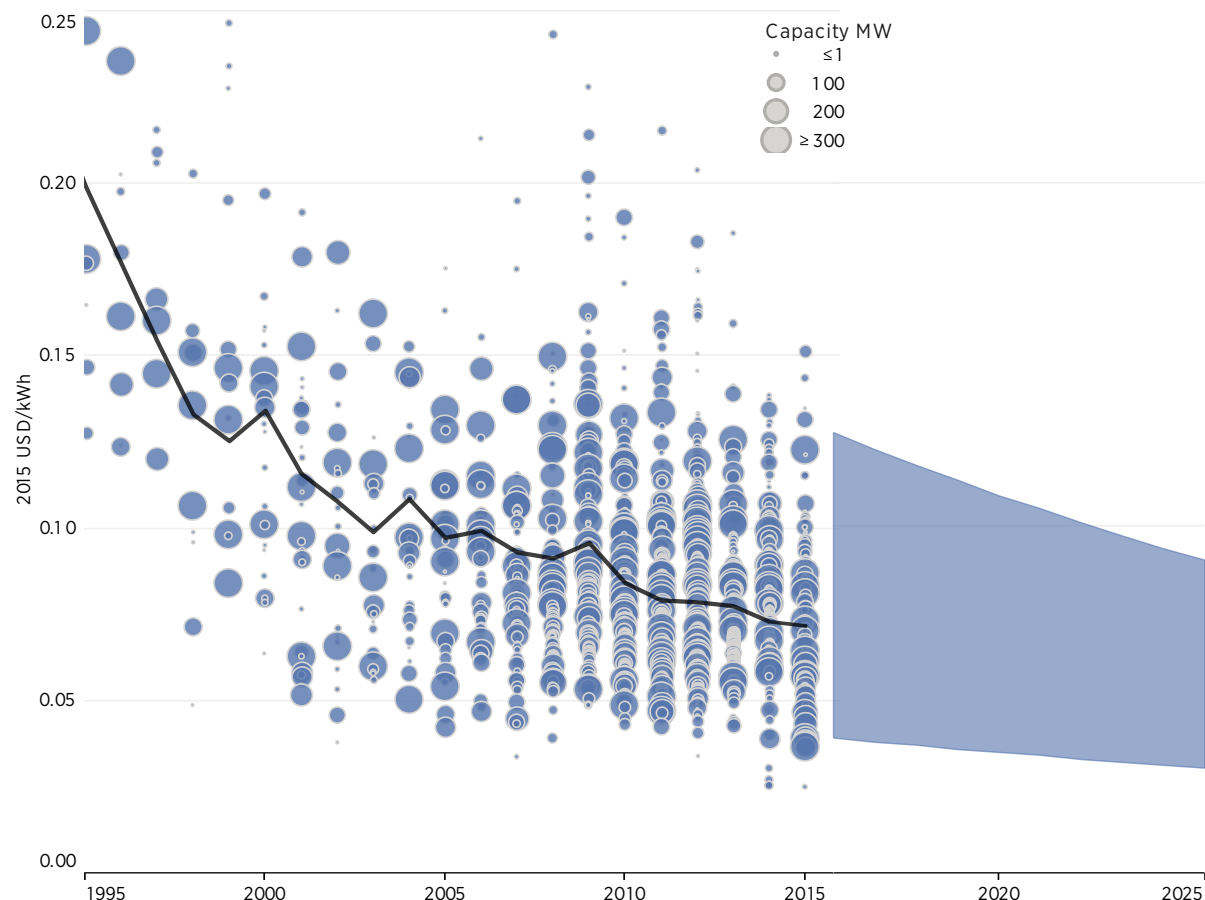
What is different, is that the drivers of this cost reduction are shifting. With low turbine prices and the reduction in total installed costs since 2008-09, future cost reductions in the cost of electricity from onshore wind are increasingly likely to come from technological improvements that yield higher capacity factors for a given wind resource. The potential improvement in capacity factors by 2025 could result in reducing the global weighted average LCOE of onshore wind by around USD 0.01/kWh, or 49% of the total projected reduction in onshore wind LCOE of USD 0.018/kWh as the global weighted average LCOE falls to USD 0.053/kWh by 2025. Reductions in total installed costs, driven mostly by cost reductions for towers, turbines and wind farm development, contribute around USD 0.006/kWh (34%) of the total reduction in the LCOE. Improvements in turbine reliability, improved predictive maintenance schedules and the more widespread application of best practice O&M strategies reduce the LCOE by around USD 0.003/kWh by 2025, or 17% of the total reduction.

Looking at the evolution of the LCOE cost range for individual projects highlights that there will remain a wide variation in project LCOEs.<sup>33</sup> At the lower end of the LCOE range, LCOEs are unlikely to fall below USD 0.03/kWh for the 5<sup>th</sup> percentile of projects. However, exceptional projects where excellent wind resources, very low installed cost structures and highly competitive O&M costs exist will challenge this lower bound. For the upper bound, the 95th percentile range for projects could fall to USD 0.9/kWh, from USD 0.11/kWh in 2015.

Similar to the potential trend for solar PV, there is likely to be a convergence in the LCOE towards more competitive costs. This will be driven by increased competitive pressures and the realisation that the rapid growth of new markets, notably in Africa and Latin America with excellent wind resources can yield very competitive new electricity

<sup>33</sup> See IRENA, 2015 for a discussion of the site-specific factors that are behind the wide LCOE ranges within and between countries for individual renewable power generation technologies.

**FIGURE 29: LEVELISED COST OF ELECTRICITY OF ONSHORE WIND, 1983-2025**



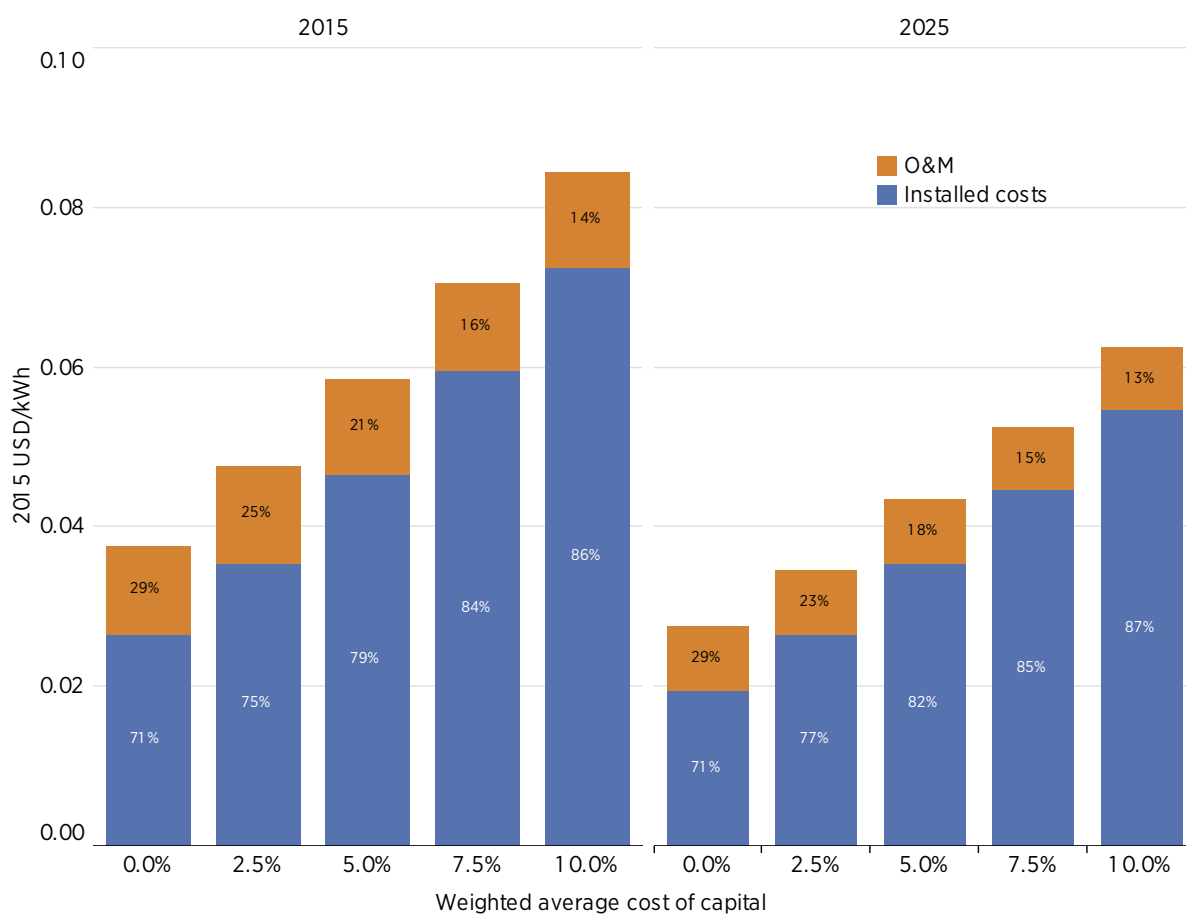
Source: IRENA Renewable Cost Database and analysis.

generation, while an increasingly international market for project developers spurs cost cutting and innovation in order to maintain project pipelines.

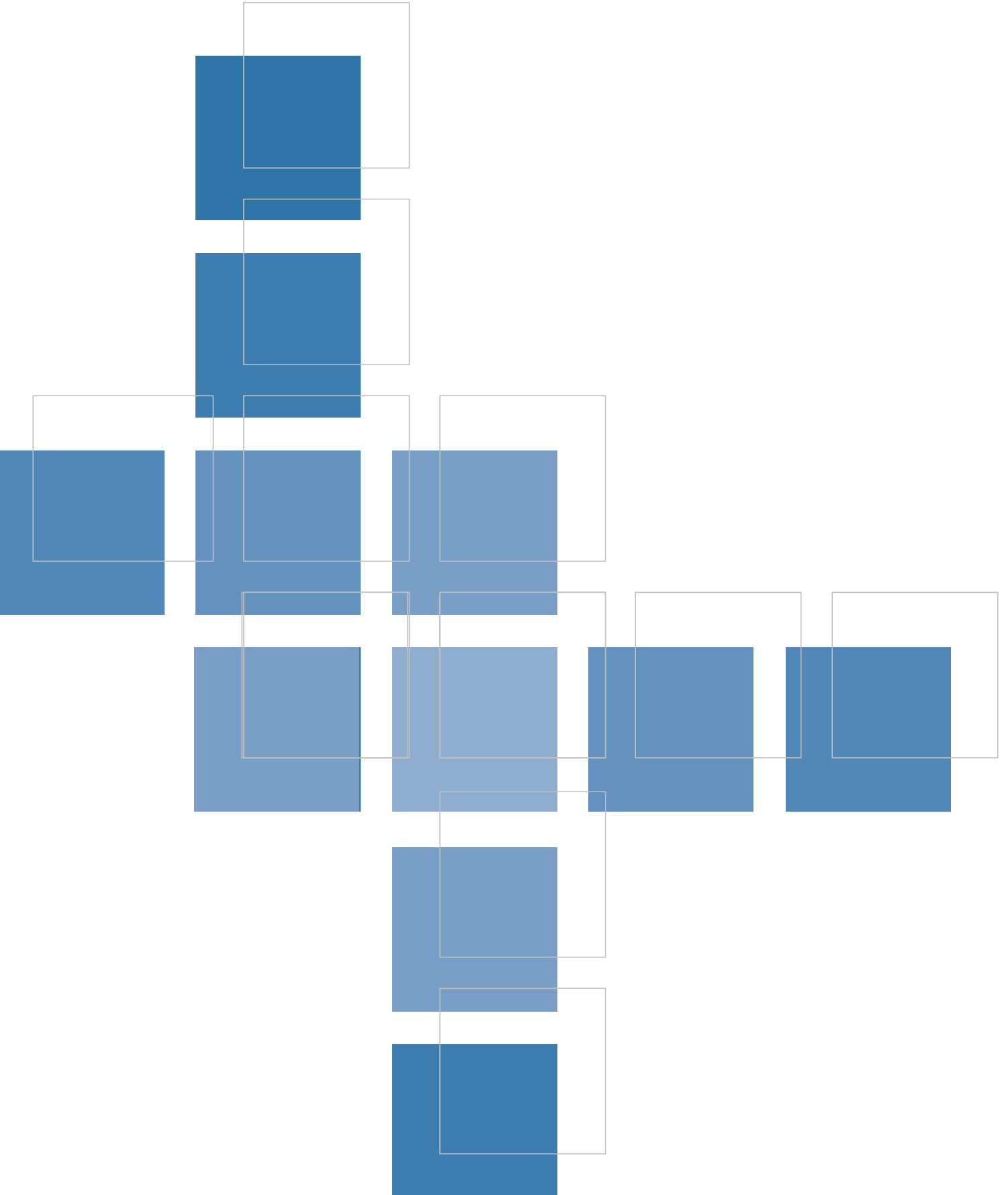
Although the O&M costs can reach 20% to 25% in European markets, the global average is somewhat

less than this with a WACC of 7.5%, reflecting the lower O&M costs in non-OECD markets (Figure 30). With no fuel costs, onshore wind is very sensitive to cost of capital variations and the LCOE of onshore wind is 78% higher at a WACC of 10% than at 2.5% in 2015 and this difference increases to 81% in 2025.

**FIGURE 30: THE SENSITIVITY OF THE LEVELISED COST OF ELECTRICITY OF ONSHORE WIND TO THE COST OF CAPITAL, 2015 AND 2025**



Source: IRENA analysis.





# 4 OFFSHORE WIND

## INTRODUCTION

Offshore wind, like CSP, is in its infancy in terms of deployment. Total installed offshore wind capacity reached 12.2 GW at the end of 2015 as a result of 3.4 GW of new capacity being added in 2015. Offshore wind deployment is concentrated in Europe, with a total installed capacity of 1.5 GW of mostly inter-tidal capacity in Asia. Reaching 12.2 GW has taken 25 years, with the first offshore wind farm commissioned in Denmark in 1991. The first project, Vindeby, was a 4.95 MW project consisting of eleven 450 kW turbines sited near the coast and in shallow waters. Vindeby and projects that followed in the last century, generally used concrete foundations and small turbines similar to those installed onshore at the time. In 2002, the first utility-scale offshore wind farm with a capacity of 160 MW (80 turbines of 2 MW each) was grid connected at Horns Rev, off the coast of Denmark.

Between 2002 and 2015, offshore wind farm projects were increasingly sited further from the coast and in deeper waters in order to access higher wind speeds. At the same time, the rated power, hub height and swept areas of turbines increased and manufacturers introduced new wind turbines that had been specifically designed for the offshore market. These new turbines increasingly standardised their components, reducing the need for expensive, specialised or custom manufacture. With the growth in turbine size, total wind farm capacities also grew. During this time, installation methods and offshore construction vessels became more sophisticated and more efficient.

## HISTORICAL AND CURRENT WIND FARM CHARACTERISTICS AND COSTS

The trend of offshore wind farms moving to deeper water and further from ports is highlighted in Figure 31. Since 2009, most projects have been

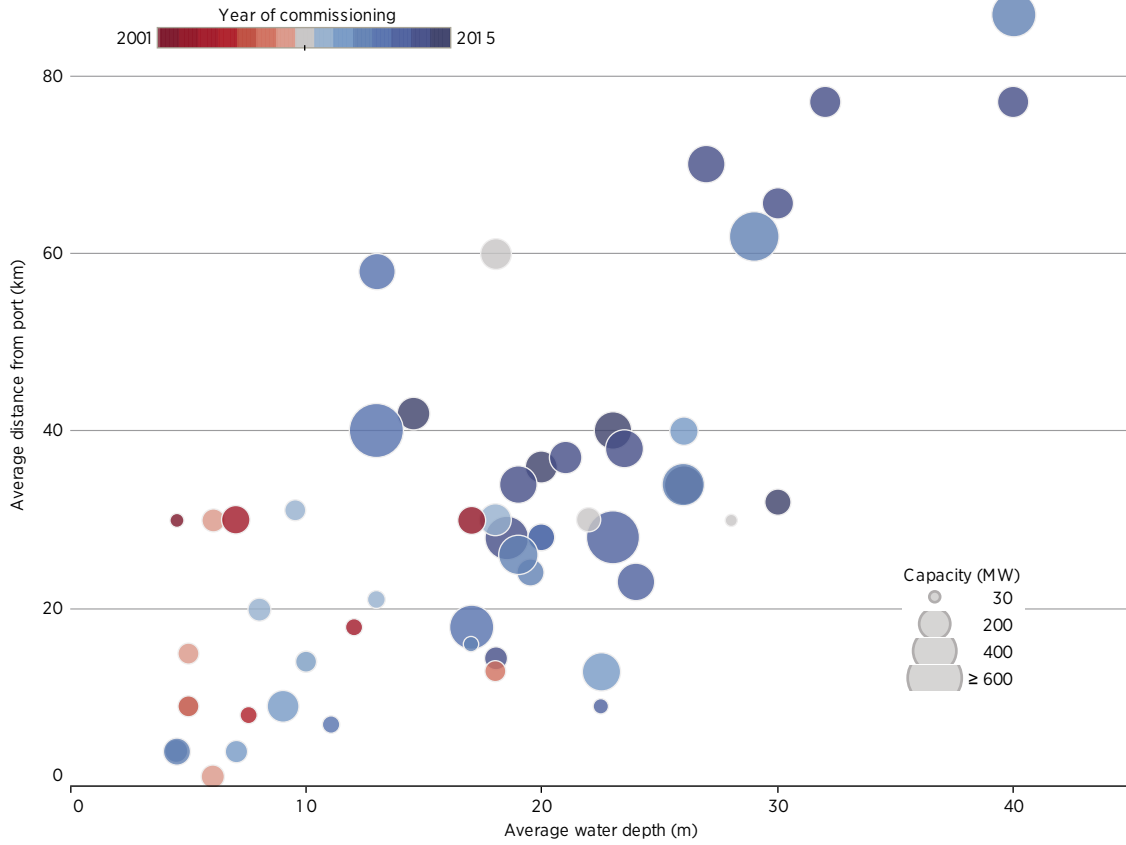
sited in water depths of 15 m or more and between 20-80 km from the nearest port. Both of these factors have an important impact on the total installed costs of offshore wind farms and O&M costs. In 2015, the average size of grid-connected offshore wind farms was 338 MW. The large offshore wind farms of Gwynt y Môr and Gemini (576 MW-600 MW) were offset by the majority of German farms being smaller (around 288 MW) (EWEA, 2016). In 2015, the average water depth of wind farms completed, or partially completed, was 27.1 m and the average distance to shore was 43.3 km (EWEA, 2016).

Today's state-of-the-art, commercially deployed turbines are 6 MW machines, such as the Siemens SWT-6.0-154 turbine with 75 m long blades.<sup>34</sup> Most turbines operational at the end of 2015, however, were in the 2-4 MW range with rotor diameters between 90 m and 120 m. In 2015, commercial offshore turbines were all three-blade upwind configurations. Hydraulic actuators or geared electric pitch motors control the pitch angle of each blade. These are computer controlled to optimise pitch angle and energy capture, while minimising loads on the blades and the rest of the turbine. Some turbines can now control the blade pitch angle of each blade separately, which can further increase energy capture and reduce loading.

Figure 32 represents the increase in turbine size and total project size between 2001-15. Until 2010, most turbines were in the 2-3.6 MW range, while since 2011, most wind farms have been using turbines in the 3.6-6.15 MW range. Since 2011, there has also been a shift to significantly larger projects. These are often developed in a number of stages, helping to unlock efficiencies in

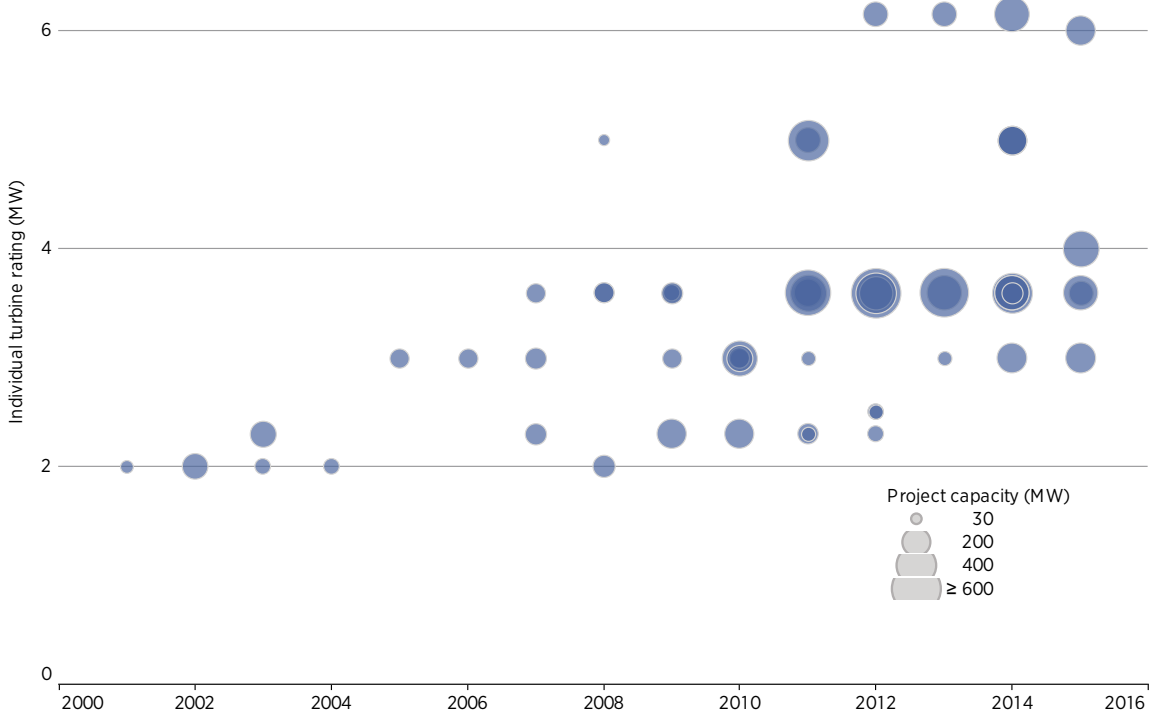
<sup>34</sup> The hub height is approximately 100 m above sea level. This is the minimum level to meet marine safety limitations on clearance between the blade tip and water for this rotor diameter, which is typically 20-25 m above mean sea level.

**FIGURE 31: OFFSHORE WIND FARM PROJECTS WATER DEPTH AND DISTANCE FROM PORT, 2001-2015**



Source: IRENA Renewable Cost Database.

**FIGURE 32: OFFSHORE WIND FARM PROJECTS TURBINE SIZE AND OVERALL PROJECT SIZE, 2001-2015**



Source: IRENA Renewable Cost Database.

infrastructure, project development, procurement and scale.

There was an increase in total installed costs in the period up to around 2010. This was mostly due to the shift to deeper waters and sites further from ports, as well as the scaling-up of offshore wind developments – although installed costs appear to have peaked around 2012/13 (Figure 33). Yet, the shift to larger turbines and, to a lesser extent, the better wind resources further offshore, meant that the LCOE of offshore wind increased less than installed costs (IRENA, 2015).

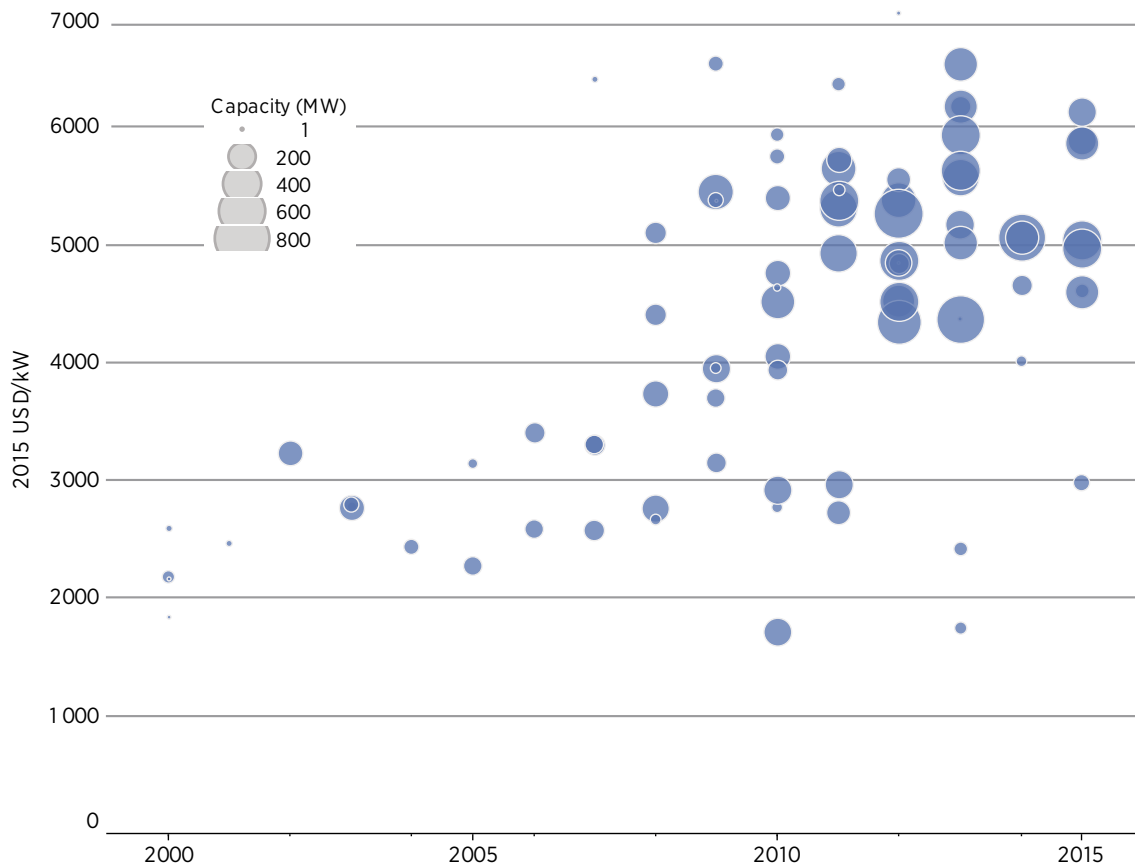
The main cost components of offshore wind farms are the turbines (including towers), the foundations and grid connection to shore. The turbine comprises the rotor, nacelle and tower, and this represents the largest cost component for the offshore wind farm, accounting for around 45% of total installed costs. Representative installed costs in 2015 for an offshore wind farm in European waters were

around USD 4 650/kW (Figure 34).<sup>35</sup> Compared to their onshore counterparts, where the turbine, tower and installation typically represents 64-74% of total installed costs (IRENA, 2015), offshore wind farms typically have a smaller share for the turbines and towers due to the higher costs offshore for other components, but reach the lower end of this range when installation costs are added in. This is despite the total costs for turbines and towers offshore exceeding the total installed costs per kilowatt of onshore wind projects.

Foundations represent a significant cost component, accounting for around 18% of total installed costs. Foundation selection depends on water depth, seabed conditions, turbine loading, rotor and nacelle mass and rotor speed. It also depends on corporate familiarity and expertise with different options, and supply chain capability

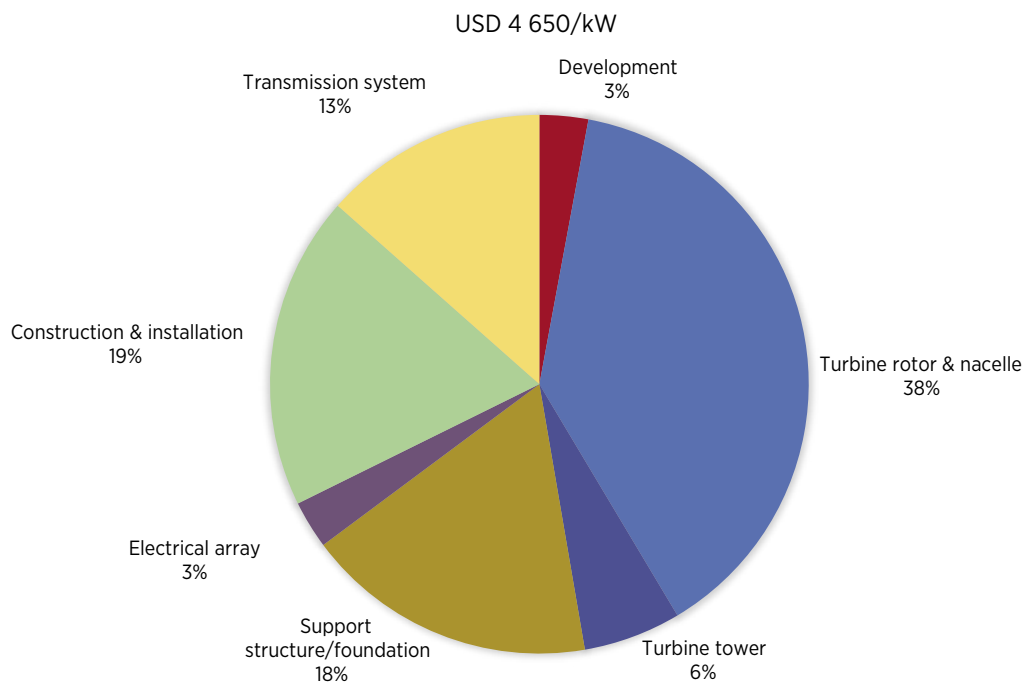
<sup>35</sup> This excludes decommissioning costs, which, when discounted back to the date of initial investment over 20 years at a WACC of 7.5%, would add around USD 110/kW.

**FIGURE 33: TOTAL INSTALLED COSTS OF OFFSHORE WIND FARMS, 2000-2015**



Source: IRENA Renewable Cost Database.

FIGURE 34: TOTAL INSTALLED COST BREAKDOWN FOR A REPRESENTATIVE OFFSHORE WIND FARM IN EUROPEAN WATERS, 2015



Source: IRENA Renewable Cost Database and IRENA, 2016b

– in both the manufacture and installation of foundations. Only fixed foundations have been used to date in utility-scale offshore wind farms, although floating concepts are under development.

There are three main groups of fixed foundations:

- » Monopiles, usually with an associated transition piece.
- » Jackets and other steel space-frame structures secured using piles.
- » Gravity base foundations made mainly from concrete.

Monopile foundations are cylindrical steel tubes that are normally driven tens of metres into the seabed. Sometimes, though, they are inserted into pre-drilled holes when conditions preclude driving. In 2015, these were the most commonly used foundations. Jackets – either braced, welded, or space-frame structures – provide required stiffness more structurally efficiently than monopiles and can become more cost effective in deeper water. Gravity base foundations are structures that are placed on the seabed, typically made from

reinforced concrete, with a mass that is sufficient to provide stability against the impact of the wave, current and turbine loads.

The electrical interconnection comprises onshore and offshore infrastructure that connects the wind farm to the existing electricity grid (the transmission system) and also interconnects the wind turbines offshore (the electrical array). The shore-based grid connection is similar to that used in onshore wind farms. The offshore electrical interconnection comprises the array cables that collect the power from strings of turbines and connect, in most cases, to an offshore substation. The offshore substation(s) contain the switchgear for the turbine strings, steps up the voltage, manages reactive power compensation and, if needed, converts to DC. Finally, the subsea export cables connect the wind farm to shore. A typical configuration is two or more offshore AC substations, although to incorporate some redundancy, some use a single substation structure with two or more transformers.

Installation is a major cost component, accounting for around 19% of total installed costs. Foundation installation is undertaken either by purpose-built jack-up vessels, also used later for turbine

installation, or by floating heavy lift vessels with dynamic positioning systems. Turbine installation is highly sensitive to high winds (>13 m/s can halt installation), which can cause significant delay and cost overruns.

The electrical installation of the array cables can be a single process of laying and burying using a cable plough, or it can be done in two stages in which a first vessel lays the cable and a second vessel buries the laid cable using a remotely operated vehicle.

## INSTALLED COST REDUCTION POTENTIAL TO 2025: TECHNOLOGICAL INNOVATION AND ECONOMIC DRIVERS

The cost reduction results for offshore wind are based on analysis conducted for IRENAs (2016c)

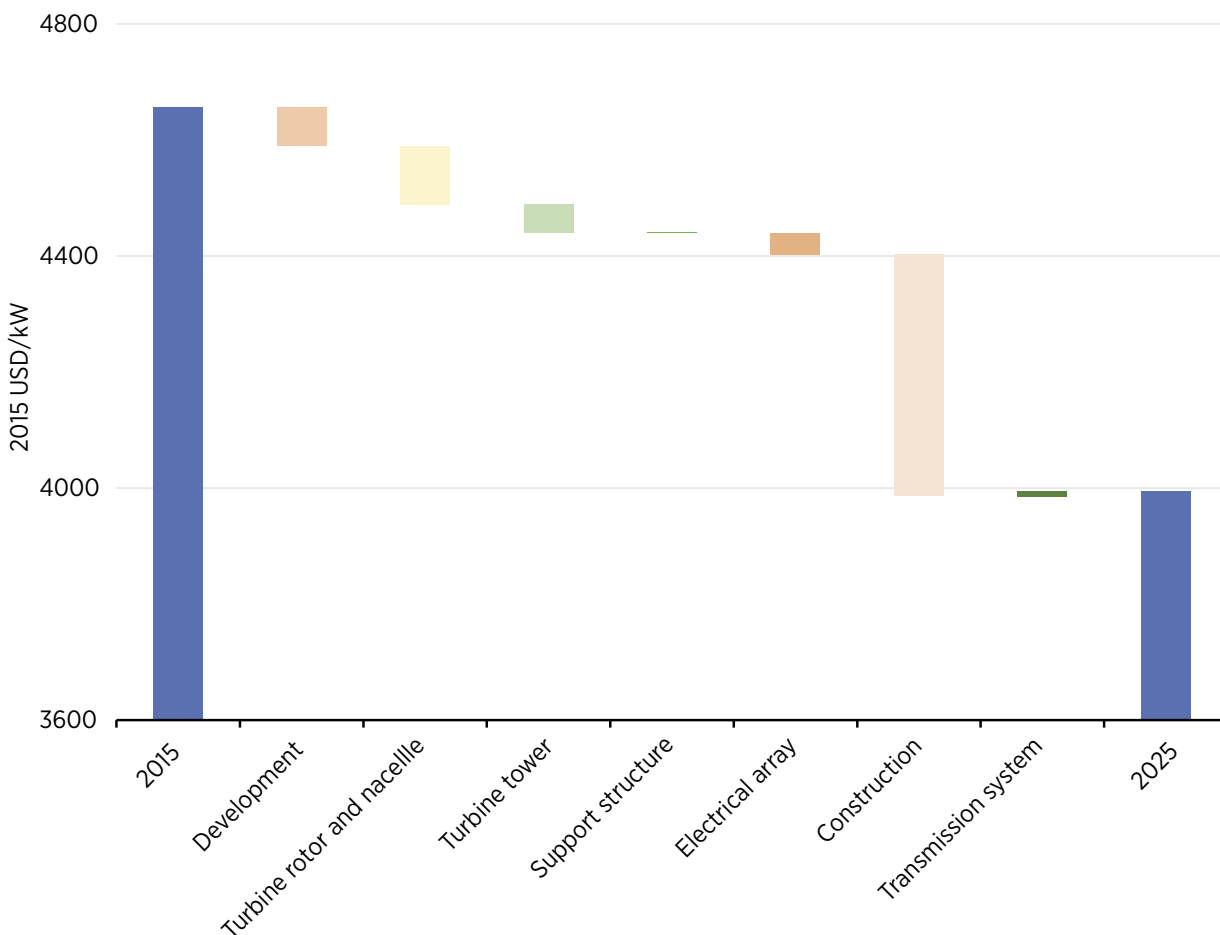
offshore innovation outlook and is complemented by other sources.<sup>36</sup> Innovations and their impacts were identified through patent analysis, industry experience, review of scientific papers and interviews with experts. They cover technological innovations that could be commercialised by 2025.

The time frame for commercialising an innovation in the offshore wind industry is typically three to six years. More complex innovations, such as larger turbines, have development periods of up to 12 years from design, prototyping, and demonstration to deployment (BVG Associates, 2012).

Overall, by 2025, there are incremental opportunities to reduce capital costs across the entire wind farm. By 2025 the total installed

<sup>36</sup> This will be published by IRENA in 2016 as Innovation Outlook for Offshore Wind Technology (IRENA, 2016b).

FIGURE 35: PROJECTED REDUCTIONS IN TOTAL INSTALLED COSTS FOR OFFSHORE WIND BY SOURCE, 2015-2025



Source: IRENA Renewable Cost Database and IRENA, 2016b.

costs of a reference offshore wind farm could be reduced by around 15% compared to today given technological innovations, learning by doing and economies of scale as the market grows. The largest installed cost reduction opportunity to 2025 is in the construction and installation of offshore wind farms (Figure 35). Construction and installation accounts for over 60% of the total installed cost reduction potential of 15% over the period. Incremental cost reductions for turbine rotors account for 15% of the total installed cost reduction, with towers accounting for 7%.<sup>37</sup> At the same time, as developers have amassed greater experience, there is the possibility to streamline and accelerate the project development process, reducing project development costs and overall installed costs.

It is important to note that there are a range of trade-offs in identifying the greatest LCOE cost reduction potentials for offshore wind farms. This means that in some cases, higher installed costs for some components can reduce the LCOE. Examples include higher cost prefabricated components that reduce installation times and costs. In addition, more expensive turbine components that deliver higher reliability will cut O&M costs and increase energy yields. Larger turbine blades that are more costly, but increase energy output, also reduce LCOE. It is therefore important not to take the installed cost reductions at face value. This is particularly true for optimisation between installed costs and electricity output, as a 10% increase in capacity factor will reduce the LCOE by around 9%. This compares to a 10% reduction in capital costs, which would reduce LCOE by around 7.6% (IRENA, 2016b).

## Construction and installation

The key opportunity to reduce construction and installation costs comes from reducing the amount of time required to install each megawatt of offshore wind, given the daily rates for offshore installation vessels and personnel are high. The

<sup>37</sup> Alternative visions of the cost reduction potential are possible. A study from 2013 (Fichtner and Prognos, 2013) anticipates a lower share of the total cost reduction to come from construction and installation costs.

trend towards larger turbines helps to some extent, but a range of other innovations are also expected to contribute. Reducing offshore installation costs can be achieved by (IRENA, 2016b; and Fichtner and Prognos, 2013):

- » Increasing the maximum wind speed at which installations may be completed: Innovations such as the use of a yoke or a crane hook to stabilise the blades during installation could help increase safe installation wind speeds to about 16 m/s, with this representing an approximate safe limit. This would provide a longer installation window and reduce weather disruptions, reducing time spent on installation.
- » Using larger jack-up vessels for installing space frame foundations: With larger decks and optimised layouts, the number of foundations carried could rise from two to three, or more. It may also be possible to do away with expensive jack-up systems for foundation installation altogether.<sup>38</sup>
- » Shifting several offshore construction operations onshore or to port: Next generation turbines have designs with a larger percentage of commissioning taking place onshore. One step further would be the assembly and pre-commissioning of wind turbines in the harbour, allowing the installation of the complete, integrated turbine (including rotor and tower) in a single operation.<sup>39</sup>
- » Integrated turbine-foundation installation: This would see the combined turbine-foundation structure towed to site by a bespoke vessel or tug boats and installed in one process. This has already been demonstrated, but has yet to be commercialised.
- » Extending the construction season by reducing underwater noise: Underwater noise can adversely affect wildlife, especially marine mammals. It is generated during sub-sea

<sup>38</sup> Both A2SEA (Denmark) and Jumbo Offshore (Netherlands) have developed innovative vessel designs as part of in-house RD&D to this end, though none have been built to date.

<sup>39</sup> One potential problem with this process is that during transit the nacelle could suffer damage from g-forces exceeding design limits, due to pitching and rolling in transit at sea.

pile installation. Reducing underwater noise propagation via a “bubble curtain” or “sleeve”, or vibration piling techniques can also result in more efficient installation processes. Vibro-piling has the additional advantage that it reduces forces on the pile, potentially allowing for lower fabrication costs.

Commercialisation of some of these innovations is starting to take place and most will be available before 2020, or shortly thereafter. Not all of these innovations will be applicable in all situations, and commercialisation may prove more or less difficult. Overall, however, they represent significant cost reduction opportunities.

In addition, installation costs can also be reduced by more efficient processes in connecting the array cables to the offshore substation. This is currently a time-consuming and expensive business because each core in the cable must be connected on-site and out of the water. Quick-connect cable terminations are being developed to complete cable connections in a simplified manner, including in the water.<sup>40</sup> Less radical solutions to speed up connections include concepts for the “pre-termination” of cable lengths.

Overall, by 2025, offshore wind farm installation could potentially require one-third to as little as one-quarter of the offshore person hours required for installation in 2015, resulting in large cost savings (IRENA, 2016b).

## Turbine rotors, nacelles and towers

Offshore wind turbines have evolved rapidly from small turbines closely related to their onshore counterparts, to large, 6-8 MW turbines specifically developed for offshore installations. The ongoing growth in turbine size, continued innovation in drive trains, blade design, wind turbine concepts

<sup>40</sup> The European Union WetMate project is at the engineering study phase and focused on wave and tidal arrays, but serial production could make this a viable technology for offshore wind underwater connection. The Energy Technologies Institute (United Kingdom) provided funds to MacArtney (Denmark) to develop a prototype 11-kilovolt (kV) quick-connect cable termination as part of its collaborative RD&D programme.

and assembly all offer opportunities to reduce installed costs and raise electricity yields.

For offshore wind turbines, the main areas for innovation are improvements that focus on reducing installed costs; improving reliability, which will reduce O&M costs and improve electricity yields; and improving efficiency to increase capacity factors.

The electricity yield and reliability improvements discussed here are also related to installed cost reduction opportunities. The main turbine improvements will relate to (IRENA, 2016b):

- » Blade tip speed: Increased blade tip speeds can be envisaged as noise constraints are less pronounced than onshore. Higher speeds can improve electricity yields and, by reducing drivetrain torque loading, also reduce installed costs. This reduction will be modest, however, because greater foundation costs occur from higher loads.<sup>41</sup>
- » Blade design and manufacturing improvements: These could include enhancement of existing designs, including new aerofoil concepts and improved passive aerodynamics unlocked by new, advanced tools and modelling techniques. This also includes novel materials and manufacturing processes that give stiffer, lighter, lower cost and higher quality blades.
- » The introduction of innovative drive trains: This includes the introduction of direct drive and mid-speed drive trains, continuously variable drive trains, and superconducting generators. The last two technological developments can contribute to lower installed costs.
- » The introduction of new power take-off systems: This can help reduce installed costs and improve electricity yields. New AC take-off systems use advanced materials (e.g., silicon carbide or diamond) to achieve greater reliability in smaller, more efficient and faster

<sup>41</sup> Another issue is that this will require improved repair processes, as even today, offshore blades experience higher leading edge wear than onshore systems, and this will be exacerbated by an increase in blade tip speed.

switching power conditioning units. A DC take-off system would eliminate the need for a power converter, which converts the DC current from the generator back to grid frequency AC. This would save on capital costs and increase reliability. DC collection also reduces the number of array cable cores from three to two and material needs by 20-30%. The first commercialisation of this is likely to be in wind farms commissioned by 2025.

- » Improved hub assembly components: These include improved bearing concepts and lubrication, hydraulic and electric systems, back-up energy sources for emergency response and grid fault ride-through, and hub design methods and material properties. These will reduce installed costs and improve reliability, reducing unplanned maintenance costs and outages.

The ongoing trend towards increased turbine ratings – the commercialisation of 10 MW turbines is likely to take place in the early 2020s – will help support the introduction of many of these innovations in

blade and drive train technology. Yet this trend may also necessitate new innovations as rotor diameter and tower heights increase. These innovations will include those in modular blade technology, where different materials can be incorporated into blade components that are eventually assembled together. Assembly could also be closer to the wind farm site than it is currently. These larger turbines will slightly reduce the savings in installed cost per kilowatt that can be achieved through some of the innovations, however, as higher hub heights and longer blades are, per kilowatt, typically more expensive without light-weighting. Yet, this factor has already been taken into account and all cost reductions presented in this report are net.

Other potential innovations include the development of downwind and/or two-bladed turbines that have lower rigidity requirements due to decreased issues with tower clearance, and therefore can be built cheaper and lighter given that the flex tolerances are larger. The drawback is that two-blade turbines result in increased noise, from faster blade tip speeds, and greater visual intrusion. These issues are, however, less relevant offshore.

## BOX 4

### Drive train innovations to 2025

In 2015, a range of drive train innovations were under development. The first is a continuously variable transmission using a hydraulic or mechanical device to provide a variable ratio of input to output speed between the rotor and a synchronous generator. This removes the need for a power converter, as the variable transmission device provides compliance and generator speed control. This reduces installed nacelle costs, as it allows the use of less expensive generators and avoids the need for power converters. Electricity yield is also increased, as this configuration should have improved reliability. This innovation has the potential to be used in some of the next generation of offshore turbines that will be commercialised in the early 2020s.

Superconducting generators are another option for future wind turbines, as they use wires that have zero electrical resistance when cooled below a critical temperature. This reduces installed costs by avoiding the use of expensive rare-earth metals that are used in permanent magnet generators (today's standard) and improves electricity yields as the generator is more efficient due to lower internal losses. Technical advances in recent years have increased the critical temperature of wires to more than 77° Kelvin, so that cooling can be achieved with liquid nitrogen, making their use much more feasible. Further innovations are anticipated in the efficiency of the cooling system and its insulation. This has the potential to be used in some of the next generation of offshore turbines that will be commercialised in the early 2020s (IRENA, 2016b)



## Wind farm development, foundations, electrical arrays and transmission systems

Although less important than installed cost reductions from construction and installation and from the turbines, improvements and innovations in wind farm development, foundations, electrical arrays and onshore transmission connections all contribute to reducing installed costs.

For offshore wind farm development costs, the major opportunities to reduce installed costs lie with (IRENA, 2016b):

- » improved wind resource characterisation
- » improvements in seabed characterisation
- » improvements in wind farm design software.

Floating Light Detection and Ranging (LiDAR) technology uses lasers to measure wind speeds at points remote from the sensor. They can be mounted offshore on buoys that avoid the need for installing fixed seabed-mounted meteorological stations. They are therefore cheaper and faster to install. They can also be moved to different sites in the wind farm to give a fuller assessment of the wind resource. Although the first project using LiDAR data will come online in 2016, further work remains to achieve “deploy and forget” devices.

Improvements in seabed characterisation can help reduce uncertainty and allow for more appropriate equipment and material selection, reducing installed costs and installation times. Although the necessary geotechnical analysis to remove these uncertainties is costly, greater investment in seabed surveys lowers construction risk and therefore costs.

Similarly, innovations in wind farm design software allow developers to optimise wind farm layout and technology choice based on multivariate analysis and improved wind modelling (Fichtner and Prognos, 2013; and IRENA, 2016b). Early versions of such software have already been used on projects that were committed to in 2015, though there is potential for further progress.

There is an opportunity to reduce cable costs by choosing the most suitable (smaller) cable core size, insulation thickness and mechanical protection for the site conditions. There are two issues with this:

- » Developers tend to demand cable specifications higher than industry standard.
- » Aspects of the standards themselves are sometimes well in excess of safe margins.

There are several opportunities to reduce the installed costs associated with the electrical array connecting the turbines offshore and the transmission system to shore. The introduction of AC array cables with higher operating voltages means capacity can be increased and electrical losses can be reduced. As the industry moves towards larger turbines, the need for higher capacity array cables becomes more critical to minimise the total array cable length and the number of substations required. For example, it is only feasible to accommodate 40 MW (or five 8 MW turbines) on a 33 kV string of 630 mm<sup>2</sup> copper cable, while it is possible to increase this to 80 MW (ten 8 MW turbines) on a 66 kV string using the same conductor size.

For transmission systems, up to at least 2018, grid connections greater than about 80 km will require an expensive high-voltage direct current (HVDC) system to avoid high losses, due to the reactive resistance in export cables. However, HVAC long-distance transmission alternatives are being developed to avoid some of these incremental costs and could be commercialised in the early 2020s (IRENA, 2016b). These include:

- » Intermediate reactor stations: These restore current and voltage phases (as proposed for the UK Hornsea 1 project).
- » Low frequency transmission: This has been the subject of some academic research and has the benefit of reducing the capacitive effects of the export cable for a given power rating.
- » Higher voltage cables that have lower losses for a given power rating: Their adoption in

offshore wind farms is likely to be incremental, but the development of 400 kV cables will lead to weight reduction and easier installation. Export at 400 kV also offers a reduction in onshore electrical infrastructure.

For offshore substations, standardised designs with lower series costs and modular substation arrangements are just starting to be deployed (IRENA, 2016b and Fichtner and Prognos, 2013). The latter reduce weight and the need for a heavy lift vessel, reducing installation costs. They also reduce the risk of the weather disrupting installation, as smaller lifts are less sensitive to sea state.

Another opportunity to reduce installed costs comes from using multiple smaller substations that can be placed on turbine foundations, rather than separate platforms, that also reduces the complexity of the switchgear and auxiliary systems. For example, Siemens has proposed two smaller wind farm level substations rated at about 250 MW, rather than one at 500 MW (Siemens, 2011), reducing overall weight by one-third and cost by 40%.

Cost reduction opportunities for foundations revolve around ongoing improvements in design, standards, jacket manufacturing, the introduction of suction bucket technology and self-installing gravity based foundations, and continuous production to achieve learning benefits and economies of scale (IRENA, 2016b and Fichtner and Prognos, 2013).

Monopile designs have evolved significantly and are now expected to remain cost competitive – even with larger turbines in water depths of over 35 m. These designs are now considered largely optimised, but evolutionary improvements are still anticipated for the transition-piece connection and the cable entry and termination.

As jacket designs become more commonly used for projects in deeper water with larger turbines, there is greater scope for more radical improvement. For example, there is likely to be a trend toward the use of three-legged, rather than four-legged, designs. For both monopiles and jackets, developers are expected to take a more holistic approach to the

combined foundation/tower structure. For instance, some developers are planning to remove the tower from the turbine supply contract to facilitate a more holistic approach to the foundation, transition piece and tower in order to drive down costs.

There is also room for further improvement in the modelling of pile-soil interaction and in modelling the lifetime fatigue in order to reduce material costs for foundations. For jackets, improved designs will allow more units to be carried at a time on installation vessels. New fabrication facilities for jackets, based on serial fabrication including more advanced handling and welding equipment and increased prefabrication of structures/foundations, will reduce costs as a result of higher factory volumes and efficiency improvements.

The use of suction bucket technology would help reduce installation costs by more than the increased wind farm development costs required from more detailed site investigations and their higher fabrication costs. The suction bucket concept replaces the piled seabed foundation by a suction bucket drawn into the seabed by a combination of the foundation's own weight and applied hydrostatic pressure. Commercial deployment of suction bucket foundations is anticipated for projects commissioned in the early 2020s.

Self-installing gravity base foundations are either concrete structures or concrete-steel hybrids. Their introduction reduces the cost of installation because they can be towed to site using standard tugs. They can then be positioned and installed without the use of costly heavy-lift installation vessels. Similar to suction bucket foundations, commercial deployment of buoyant foundations is anticipated to occur for projects commissioned in the early 2020s.

## **IMPROVED ELECTRICITY YIELDS (CAPACITY FACTORS) FROM THE SAME WIND SITE**

In addition to the innovations described above that reduce installed costs and improve capacity factors, there are a number of other innovations that will help improve the overall capacity factor of offshore wind over the 2015-25 period. These include

improved blade control and additional drive train improvements not previously discussed, as well as improvements in O&M systems (IRENA, 2016b).

In terms of blade control, improvements include the use of LiDAR to measure the wind flow approaching the turbine, so the blades can be adjusted to optimise energy capture. Another improvement will be the introduction of active aero control on blades (flaps, activated surfaces, plasma fields and air jet boundary level control) to locally optimise the aerodynamic performance of individual sections of the blade and therefore improve efficiency. All these innovations will contribute to higher energy outputs for a given resource, with both theoretical modelling and practical trials of their application already underway.

Drive train improvements, such as direct drive and mid-speed drive trains, have the potential to increase reliability by reducing the number of critical components. Reduced planned and unplanned maintenance will result in higher availability, and therefore output, and will be incorporated in wind farms commissioned from 2017 on.

The net result of the innovations and technological improvements in offshore wind development, turbines and operation is that the energy yield from a given wind resource will increase by around 4% between now and 2025 (Figure 36). Some issues will work against higher capacity factors, notably environmental constraints, and potentially higher losses from transmitting electricity from developments further offshore.

## OPERATIONS AND MAINTENANCE COSTS

The main opportunities for O&M cost reductions to 2025 are (IRENA, 2016b and Fichtner and Prognos, 2013):

- » improvements in weather forecasting and analysis
- » introduction of turbine condition-based maintenance strategies
- » improvements in O&M strategies for far-from-shore wind farms

**FIGURE 36: PROJECTED IMPROVEMENT IN ELECTRICITY YIELD AT OFFSHORE WIND FARMS FOR THE SAME QUALITY WIND RESOURCE, 2015 AND 2025**



Source: IRENA, 2016b.

- » improvements in personnel transfer and access
- » introduction of remote and automated maintenance
- » introduction of wind-farm-wide control strategies.

Improvements in weather forecasting increase the efficient use of staff and vessels. They also reduce lost energy production by maximising activity during good weather windows. This requires advances in the accuracy and the granularity of forecasts, given that accuracy drops significantly for forecasts beyond five days ahead for an area of approximately 100 km<sup>2</sup>. This is a significant problem given reasonable accuracy needs to be extended to 21 days when heavy offshore work is required.

Condition-based maintenance reflects the risk of failure according to operating experience, rather than interventions at fixed time intervals. New and improved prognostic and diagnostic systems and processes allow operators to maximise turbine energy production and minimise unnecessary maintenance interventions. Increases in yield from this approach are likely to more than offset the small increase in turbine installed costs required for data collection and analysis.

Currently, O&M strategies for wind farms more than 50 km from shore are still evolving. A small number of service operation vessels (SOVs) with accommodation for about 50 technicians, office space, workshops and welfare facilities have entered the market, with Siemens pioneering their use. The optimisation of SOV use and design is an ongoing process and these larger vessels could support a number of daughter vessels. Fixed offshore bases may even become cost effective for some projects. General improvements in maintenance crew transfer can also be expected. Another opportunity to reduce expensive onsite interventions will come from the introduction of remote and automated maintenance (e.g.; drone-based blade and turbine inspections).

There will also be economies of scale for offshore O&M. As a number of wind farms could share O&M equipment and infrastructure. This will be

aided by the development of still larger and more reliable turbines and enhanced remote monitoring, prognostics, logistics and online documentation, enabling a higher fraction of failure to be fixed on the first visit and before there is any impact on other components.

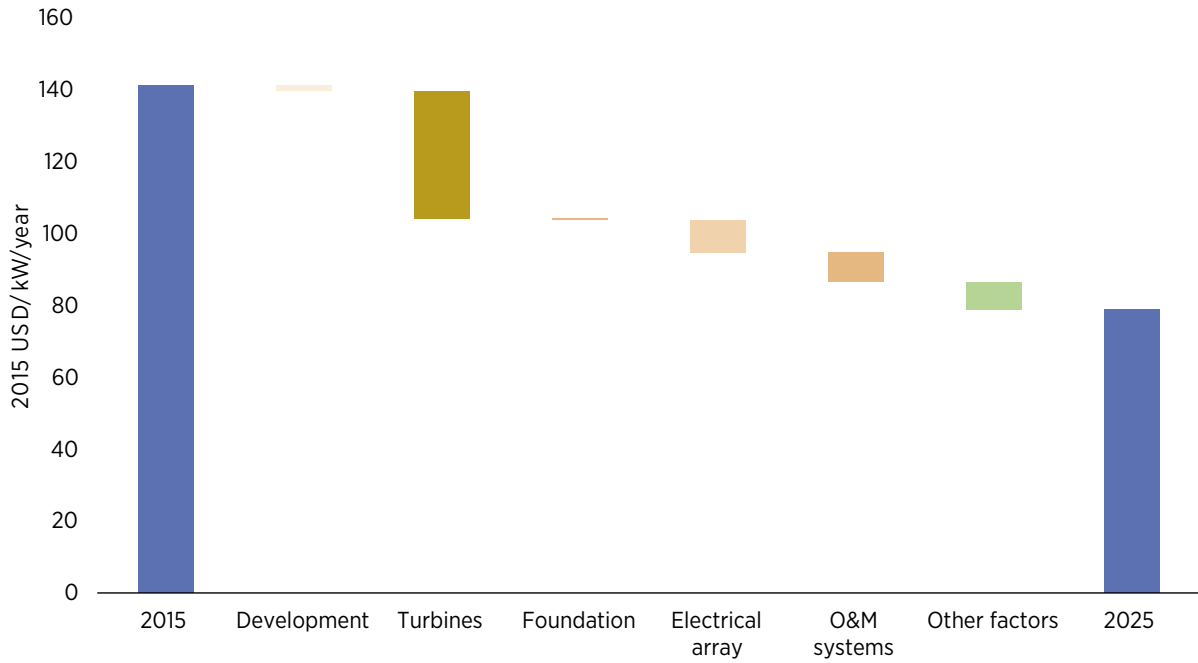
The potential total reduction in annual O&M costs is estimated at around 44%, falling from USD 141/kW per year in 2015 to USD 79/kW per year in 2025 (Figure 37). Improvements in turbine reliability and improved ease of maintenance are expected to account for around 57% of the O&M cost reduction potential. Scheduled maintenance costs could potentially decline by 34% compared to 2015 and by around half for unscheduled maintenance costs. Potential reductions in O&M costs related to the electrical array account for 15% of the total O&M cost reduction potential, improved O&M systems and procedures for 13%, and other factors for 12%.

## POTENTIAL REDUCTIONS IN LCOE BY 2025

The combination of the technological and process innovations in the development and operation of offshore wind farms could potentially see the average cost of electricity from these fall by around 35% from around USD 0.17/kWh in 2015 to USD 0.11/kWh in 2025 (Figure 38). This represents a central estimate of the cost reduction potential, but there will be a range of possible outcomes. These will depend on the individual specifics of each offshore wind farm project, the rate at which different innovations are introduced in different markets and uncertainty around the order of magnitude of the benefits of the technical and process-based innovations identified in this report.

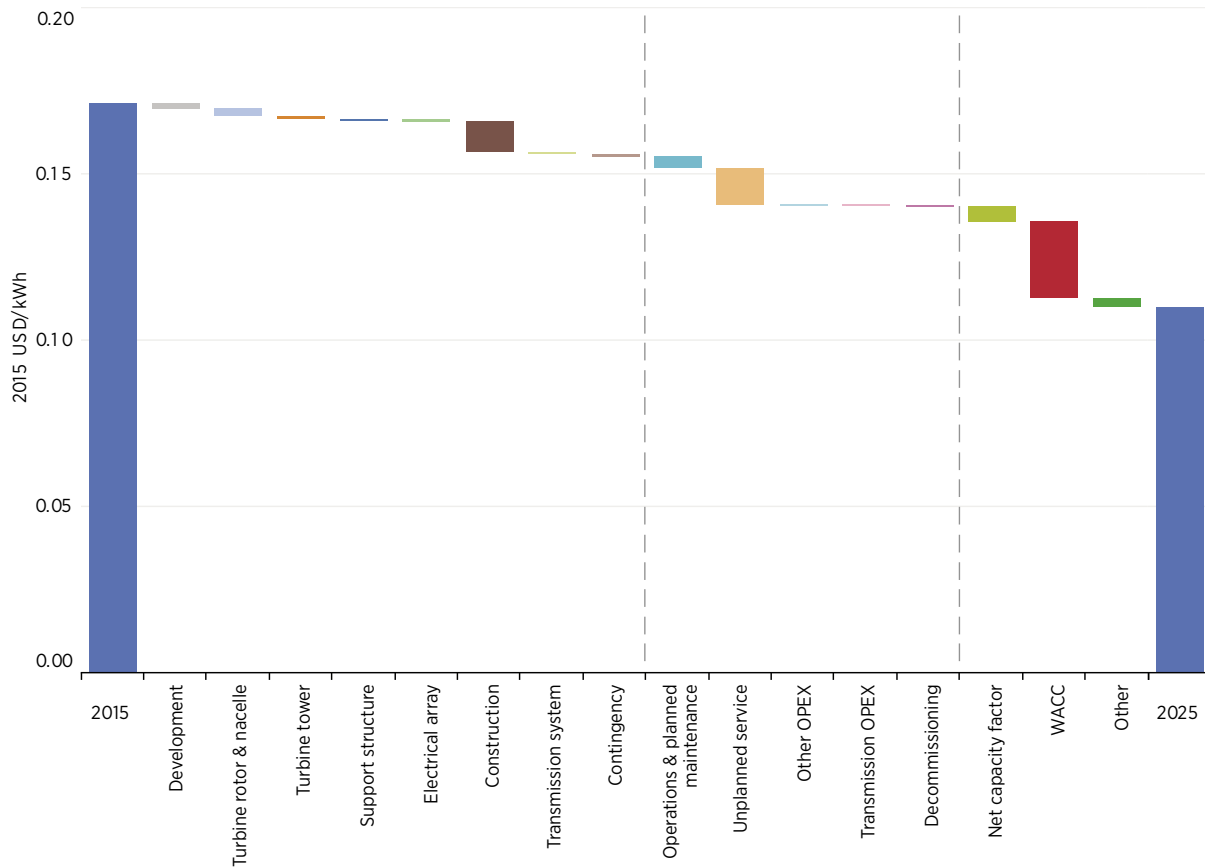
Reductions in the total installed costs of offshore wind farms account for around 24% of the total LCOE reduction potential, with reduced construction and installation costs accounting for 57% of this reduction. The innovations in turbine reliability, O&M strategies and preventative maintenance should result in significant improvements in the LCOE due to reduced unplanned servicing needs. The reduction in unplanned servicing could contribute around 17% of the total LCOE cost reduction potential between 2015 and 2025. The

FIGURE 37: OPERATIONS AND MAINTENANCE COST REDUCTION POTENTIAL BY SOURCE, 2015-2025



Source: IRENA, 2016b

FIGURE 38: OFFSHORE WIND LEVELISED COST OF ELECTRICITY REDUCTION POTENTIAL, 2015-2025



Source: IRENA analysis.

reduction in planned operations and maintenance expenditures will account for 6% of the total cost reduction potential. Overall, the reduction in O&M costs of USD 0.018/kWh will reduce the share of O&M in total LCOE from 30% today to 23% in 2025. Technological innovations in turbine design and manufacture, as well as control strategies and improved reliability, will result in improvements in the capacity factor of offshore wind farms. This will account for around 8% of the total LCOE reduction.

By far the largest cost reduction potential will come from the reduction in the WACC. This will come from greater developer experience and improved project development and commissioning practices. It will also come from the fact that a wider range of financing institutions will acquire experience with offshore wind farm risks and be able to more realistically price these risks.

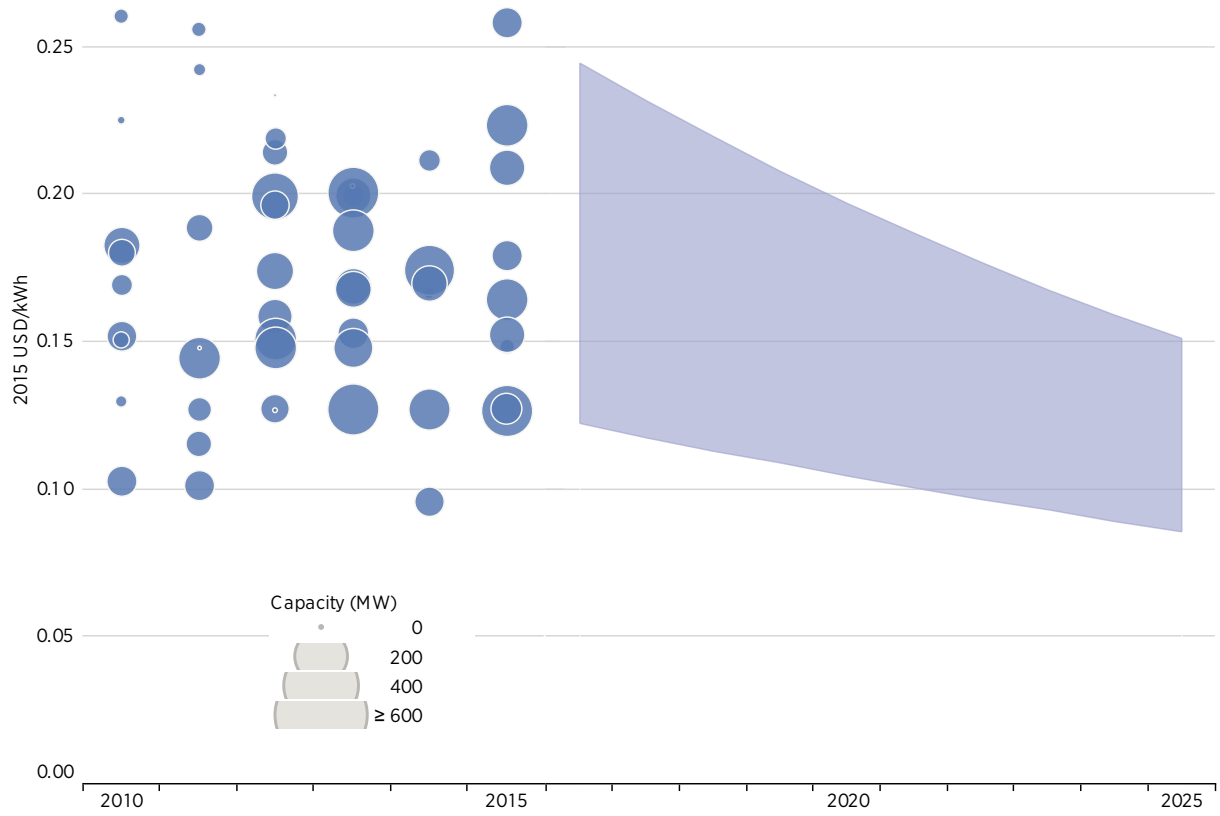
In total, reducing the WACC from the current 8-10% to an average of around 7.5% will account for around 43% of the total potential reduction in the LCOE of offshore wind by 2025. In addition to an increasingly experienced industry and a better understanding by all players of the technology, the significantly increased scale of the proposed offshore wind farms in the period to 2025 will be a contributing factor to this WACC reduction. The

current batch of gigawatt-sized proposals for a series of wind farms provide the scale to attract the most experienced financial organisations. These proposals will also attract institutional investors that can ensure the most competitive costs of capital are achieved.

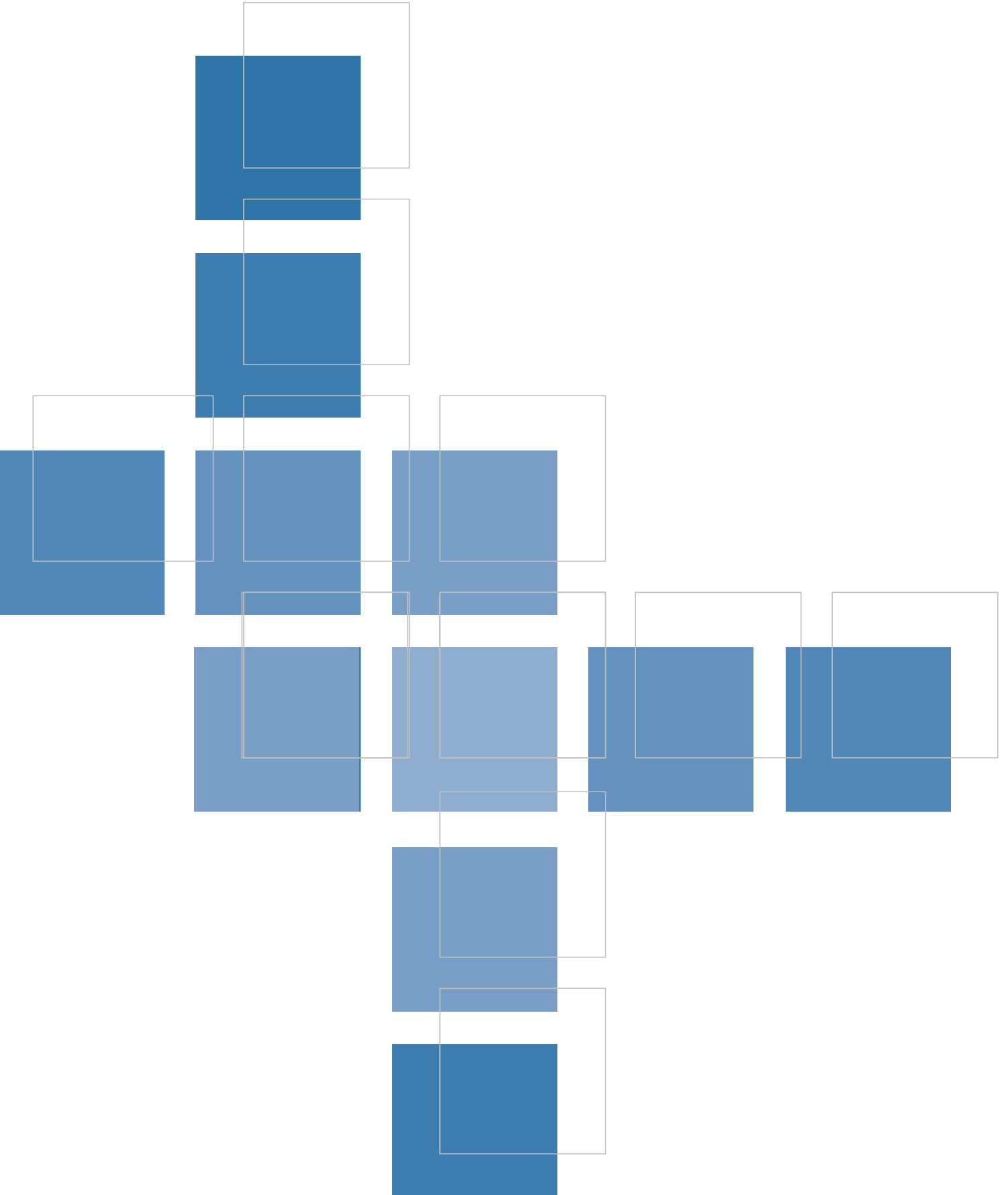
Looking at the range of possible project configurations, while allowing for the impact of national policies on cost allocations, a range of possible outcomes can be seen for the LCOE evolution of offshore wind in different markets. Figure 39 presents the historical evolution of the LCOE of offshore wind between 2010 and 2015 for the data available in the IRENA Renewable Cost Database. It also shows a projection for offshore wind LCOE evolution to 2025.

Offshore wind projects in tidal or near-shore locations could see costs fall to as little as USD 0.08/kWh by 2025, while projects in deeper water will always incur higher costs, although these could potentially fall to USD 0.15/kWh. This analysis is broadly consistent with other recent analyses of the potential for offshore wind cost reductions out to 2025-30 that have been prepared by industry associations, consultancies and academics (BVG Associates, 2012; Fichtner and Prognos, 2013; and KIC InnoEnergy, 2014b).

FIGURE 39: HISTORICAL OFFSHORE WIND LCOE BY PROJECT AND PROJECTIONS TO 2025



Source: IRENA Renewable Cost Database and IRENA, 2016b.





# 5 CONCENTRATING SOLAR POWER

## INTRODUCTION

Concentrating solar power plants use mirrors to concentrate the sun's rays. In most systems today, this heats a fluid used to produce power-generating steam. CSP plants then generate electricity in a similar way to conventional power stations, using steam turbines.

The first CSP plants were built in the 1980s in the Mojave Desert in California. After a lull in activity during the 1990s, there was a renaissance for the technology in the 2000s driven by support policies that resulted in commercial projects in Spain and the United States. As a result, these two countries accounted for around 88% of total installed capacity globally at the end of 2015. During the last two to four years in particular, emerging markets with high solar resources like Morocco, the United Arab Emirates, South Africa and Chile have started to gain momentum in terms of CSP deployment and plans. The technology is still in its infancy in terms of deployment, however, with total capacity of around 5 GW at the end of 2015 (IRENA, 2016c). There is thus still ample opportunity for cost reduction, as more plants are installed, economies of scale are unlocked and industry experience is gained.

CSP technologies can be divided into two types, according to the way the solar collectors concentrate the sun's rays. Parabolic trough collector (PTC) systems concentrate the rays along a single focal line of heat receiver tubes, while solar towers (ST) use a ground-based field of mirrors (heliostats) to track the sun (in two axes) and focus it on a central receiver, mounted on a high tower. With over 50 utility-scale plants installed worldwide, PTCs are the dominant technology, accounting for about 85% of cumulative installed capacity at the end of 2015. The first commercial-scale ST systems are in the early operation phase and make up another 10% of the total CSP installed capacity (ESTELA, *et al.*, 2016). Since PTC systems and ST are expected to continue to be the

dominant commercial technology to 2025, these two technologies are the focus of this paper.

## CURRENT TECHNOLOGY AND COSTS

PTC plants consist of solar collectors (trough-shaped concave mirror reflectors), heat receivers (absorber tubes), and their support structures. A single-axis tracking mechanism is used to orient both solar collectors and heat receivers towards the sun and allows the reflectors to concentrate the sun's irradiation onto the receiver tube in the trough's focal line. Inside the receiver tube, there is a heat transfer fluid (HTF) – synthetic oil in most cases today. This is heated to approximately 360-400°C.

The heliostats of ST plants, meanwhile, have a two-axis tracking system in order to concentrate irradiation onto a single receiver mounted on a central tower. STs achieve higher concentration factors by focusing more light on a single point, resulting in higher temperatures than PTC systems. This gives STs several advantages over PTC plants, including more efficient steam cycle operation.

In addition to the solar field components, CSP plants include conventional steam turbines to generate electricity and can also incorporate low-cost thermal energy storage systems. CSP plants with thermal energy storage have higher investment costs, but they also allow higher capacity factors (Figure 40), dispatchability and, typically, lower LCOEs. The ability to shift generation to when the sun is not shining and/or the ability to maximise generation at peak demand times reduces the LCOE and can result in CSP plants capturing the greater value of electricity produced during peak system periods. CSP plants are therefore increasingly including storage. For example, since 2010, 40% of Spanish plants have included five to ten hours of storage capacity (ESTELA, *et al.*, 2016).

Most state-of-the-art CSP plants use advanced “sensible heat” storage systems.<sup>42</sup> These involve the use of a two-tank system, with molten salts at different temperature levels in each tank being used as a thermal storage medium. These are charged by the HTF from the solar field through the use of heat exchangers. Using molten salts in both the solar field, as the HTF, and as a thermal energy storage medium eliminates the need for some heat exchangers and allows for higher operating temperatures. This reduces installed costs, given that heat exchangers between the HTF and the storage medium are eliminated, and reduce thermal energy storage costs as higher temperature differentials can be used between the two tanks. Though not yet commercial, research is also ongoing on other types of storage systems. One approach, based on “latent heat” storage, involves the use of phase-change materials (PCM) to transfer heat from the HTF.

## Installed costs

The current cost distribution for PTC plants is somewhat clearer than those of STs, given the former’s greater deployment. In the OECD countries, current investment costs for PTC plants without storage are typically between USD 4 600 to USD 8 000/kW, while in non-OECD countries they have been able to achieve a lower cost structure, with capital costs between USD 3 500 to USD 7 300/kW (IRENA, 2015). CSP plants with thermal energy storage tend to have higher investment costs, but they allow higher capacity factors (Figure 40), dispatchability and typically lower LCOEs (particularly for molten salt solar towers). For PTC and ST plants with thermal energy storage of between four and eight hours, installed between 2007 and 2013 – when generous support schemes were in place in Spain, in particular – costs were typically between USD 6 800 and USD 12 800/kW for projects for which data is

<sup>42</sup> Other storage options are feasible, including the use of solid heat storage materials or thermochemical (e.g., phase change materials) storage systems. As an example, phase change materials have been evaluated in conjunction with “direct steam generation” CSP technologies, given that they offer heat transfer at constant temperatures, which is needed for the evaporation process (Birnbauer et al., 2010). However, it is not anticipated that these technologies will play a significant commercial role prior to 2025, so they are not considered in this report.

available. Since 2013, costs have trended down and are in a narrower range of USD 6 100 to USD 8 100/kW. The estimated costs for the reference PTC plant where an investment decision was made in 2015 are around USD 5 550/kW and represent the competitive pressures facing CSP plants in today’s market. For the equivalent ST plants, total installed costs are slightly higher at around USD 5 700/kW for the reference plant.

## Operations and maintenance costs

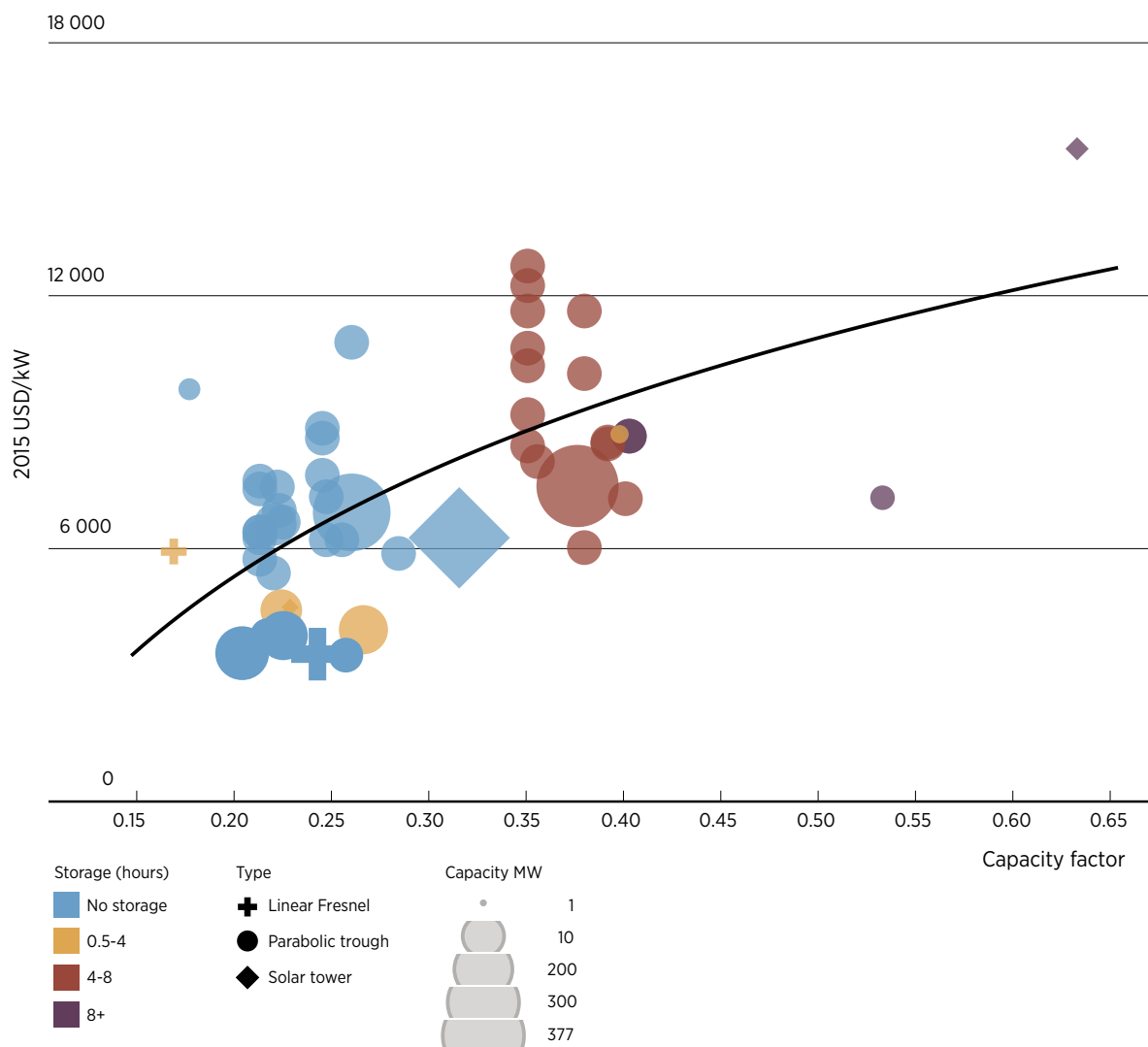
A detailed assessment of the O&M costs of the pioneering Californian Solar Electricity Generating System (SEGS) plants that were built between 1982 and 1990 estimated their O&M costs to be USD 0.04/kWh (Cohen, 1999). One of the largest areas of expenditure was found to be the replacement of receivers and mirrors as a result of glass breakage. Materials advances and new designs have helped to reduce the failure rate for receivers, but mirror breakage is still an important cost component. The cost of mirror washing, including water costs, is also significant. Plant insurance can also be a large expense, with its annual cost potentially between 0.5-1% of the initial capital cost. Even higher costs are possible in particularly insecure locations.

More recent projects built in Spain, the United States and elsewhere are estimated to have lower O&M costs than those of the SEGS plants. On the basis of available, bottom-up, engineering estimates (e.g., Turchi, 2010a and Turchi, 2010b) and recent proposed projects (Fichtner, 2010), O&M costs can be estimated to be in the range of USD 0.02 to USD 0.04/kWh (including insurance). The 2015 CSP cost analysis in this paper assumes an insurance-included O&M cost range of USD 0.02 to USD 0.03/kWh for PTC and USD 0.03 to USD 0.04/kWh for ST, which reflects the more recent trend to lower O&M costs.

## Levelised cost of electricity

Table 6 shows the key parameters for the reference plants used in this report to analyse the cost reduction potential to 2025. The reference plants

FIGURE 40: INSTALLED COSTS AND CAPACITY FACTORS OF CSP PLANTS AS A FUNCTION OF STORAGE, 2007-2014



Source: IRENA Renewable Cost Database; BNEF, 2014; GlobalData, 2014; NREL, 2014.

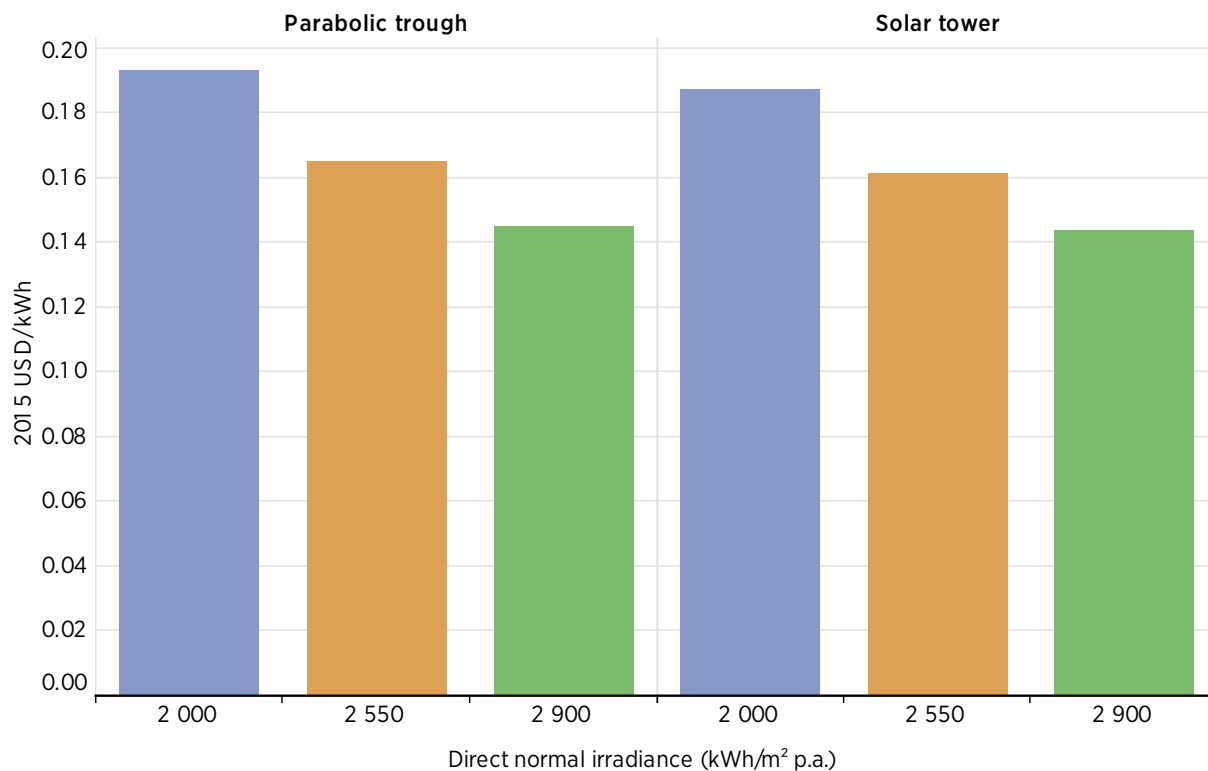
TABLE 6: KEY DESIGN PARAMETERS OF THE PTC AND ST REFERENCE PLANTS, 2015

	Unit	Parabolic Trough	Solar Tower
Site		Ouarzazate, Morocco	
Direct normal irradiation	(kWh / m <sup>2</sup> p.a.)	2 000 / 2 550 / 2 900	
Solar collector / heliostat		Ultimate Trough®	Stellio®
Heat transfer fluid		Thermal oil	Molten salt
Storage medium		Molten salt	Molten salt
Maximum HTF temperature	(°C)	393	565
Energy storage (full load hours) <sup>1</sup>	(h)	7.5	9
Gross electrical output	(MW)	160	150

Source: DLR, 2016.

<sup>1</sup> These storage levels are the result of modelling that identified minimum LCOE for both reference plants given the cost and performance assumptions and reference values.

FIGURE 41: CSP LEVELISED COST OF ELECTRICITY SENSITIVITY TO DNI FOR 2015 REFERENCE PLANTS



Source: IRENA

are roughly equivalent in size and other parameters to the Noor<sup>43</sup> plants in Morocco.

Detailed cost and performance modelling of the reference plants was performed by DLR (2016) for this report. In order to determine the final effect on the LCOE, several factors have to be taken into account. These include the complexity of CSP plants, the relative freedom in the choice of the level of thermal storage – and the impact of this choice on the installed costs and the size of the solar field.<sup>44</sup> This modelling is essential not only in understanding the impact of technological improvements on capital costs, but also on plant operation.

Sensitivity analysis has been performed for plants in different geographical locations. Three different

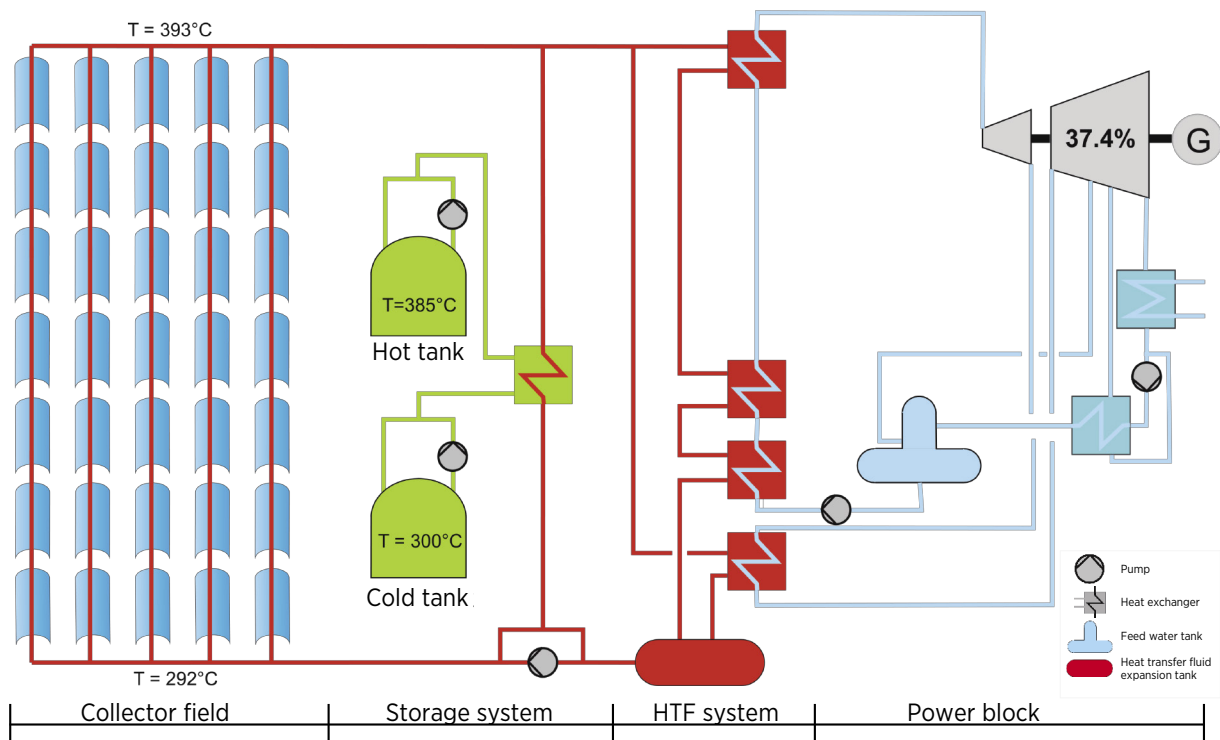
direct normal irradiance (DNI) levels – 2 000, 2 550 and 2 900 kWh/m<sup>2</sup> p.a. – have been modelled, given the importance of direct normal irradiance on plant design, output and the LCOE. Figure 41 shows this dependency and displays an LCOE range of between USD 0.14 (at the highest DNI) and USD 0.19/kWh (at the lowest DNI). Compared to the central DNI reference, for example, the LCOE of PTC systems is 17% higher under low irradiation conditions and about 12% lower at the higher DNI conditions. A similar relationship to variations in DNI is observed for STs.

Figure 42 shows a simplified scheme of the design of the reference PTC plant for 2015. This shows thermal oil in the solar field cycle (red), water/steam in the power block cycle (blue) and molten salt (green) in the thermal storage system. Each fluid has specific advantages for its field of application, but in this three-fluid design, several heat exchangers are necessary. This increases the total investment and reduces the maximum temperature of the live steam at the turbine entrance, reducing the steam turbine efficiency compared to what it could be with lower losses.

<sup>43</sup> NOOR plants project data accessed April, 2015: <http://www.worldbank.org/projects/P131256/?lang=en&tab=overview> [http://www.nrel.gov/csp/solarpaces/project\\_detail.cfm/projectID=270](http://www.nrel.gov/csp/solarpaces/project_detail.cfm/projectID=270)

<sup>44</sup> This is a fundamental design decision, as thermal energy storage requires a larger solar field in order to send excess heat to storage during the day to allow for generation when the solar irradiance is insufficient to maintain generation output.

FIGURE 42: REFERENCE PARABOLIC TROUGH SYSTEM DESIGN, 2015



Source: DLR, 2016.

Note: Thermal oil as heat transfer medium (red) and molten salt is the storage medium (green). The water/steam circuit is also shown (blue). The letter "G" represents the generator.

## COST REDUCTION POTENTIALS

In each year and for each technology, specific technology configurations have been modelled for the analysis in this report, resulting in four cases used as a reference to evaluate the reduction potential of PTC and ST plants to 2025 (Table 7). As already highlighted, the sensitivity of the LCOE results to different plant locations, with better and worse solar resources, was also modelled. In addition to technological improvements, the impact of improved economies of scale as the market for CSP grows, as well as more efficient supply chains, were also taken into account.

The technology configurations in 2015 and 2025 include a key improvement in the PTC case. This is a switch from thermal oil VP-1<sup>45</sup> for the HTF of PTC plants in 2015 to solar salt<sup>46</sup> in 2025. This HTF

<sup>45</sup> An ultra-high temperature oil, which is a Biphenyl/diphenyl oxide (DPO) eutectic mixture.

<sup>46</sup> Solar salt (40% KNO<sub>3</sub>, 60% NaNO<sub>3</sub>).

switch (shown schematically in Figure 43) enables higher process temperatures and reduces installed costs and LCOEs significantly. The steam turbine generation efficiency will increase by around 14% to 2025, from a net 37.4% in 2015 to 42.7% in 2025 as a result of higher operating temperatures and reduced parasitic losses. In addition, higher temperatures contribute to improving the system's thermal storage performance and allow for reduced storage volumes for a given level of storage (measured in hours of generation), in addition to eliminating the need for heat exchangers between the storage salt and thermal oil<sup>47</sup> HTF.

Since the temperature difference between the cold and the hot molten salt tanks can be approximately doubled with the use of solar salt as the HTF, the needed storage volume for the same storage capacity in hours can be cut by more

<sup>47</sup> Not only can this heat exchanger be omitted, but also storage tanks and auxiliaries for the thermal oil (not shown in Figure 42 for simplicity).

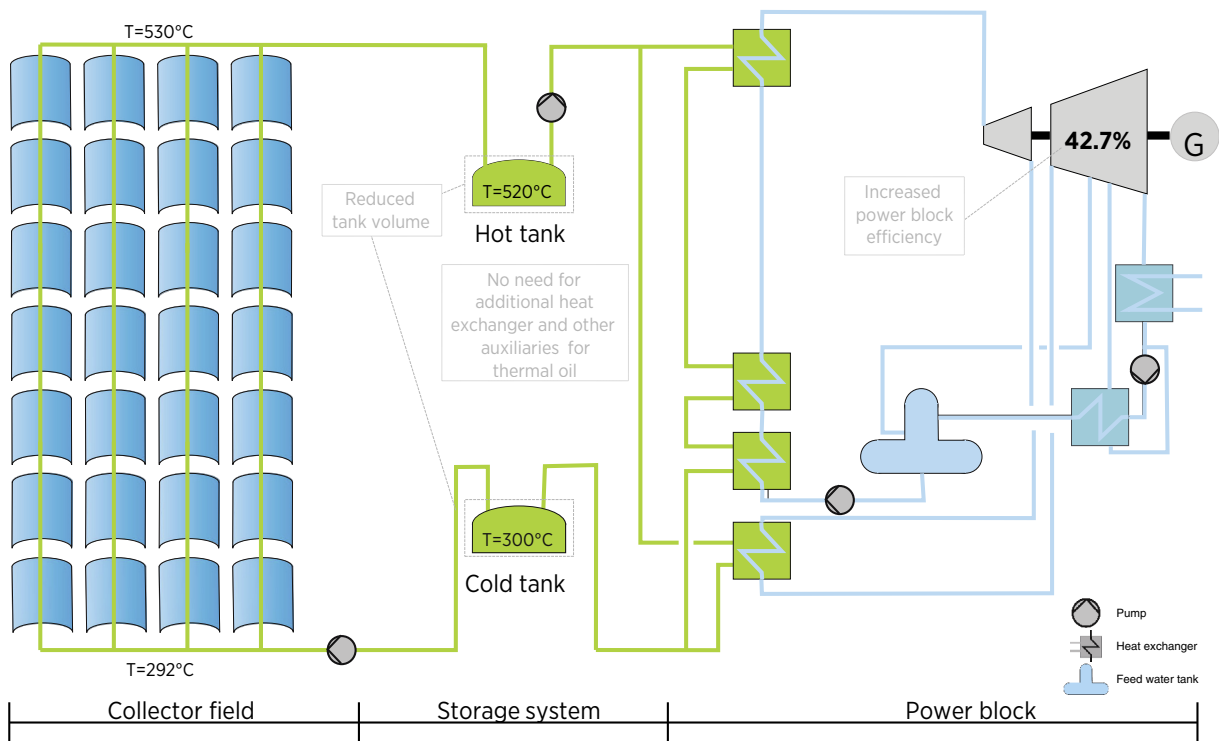
TABLE 7: KEY TECHNOLOGY VARIATIONS IN THE REFERENCE PTC AND ST PLANTS, 2015 AND 2025

	Cooling <sup>1</sup>	HTF	HTF max temp.	Live steam temperature
<b>PTC 2015</b>	Dry	VP-1	393°C	383°C
<b>PTC 2025</b>	Dry	Hitec	530°C	520°C
<b>ST 2015</b>	Dry	Solar salt	565°C	550°C
<b>ST 2025</b>	Dry	Solar salt	600°C	585°C

Source: DLR, 2016.

<sup>1</sup> Dry cooling is a viable option for curtailing water demands. A direct air-cooling system, typically known as an aircooled condenser (ACC), is assumed in all four cases.

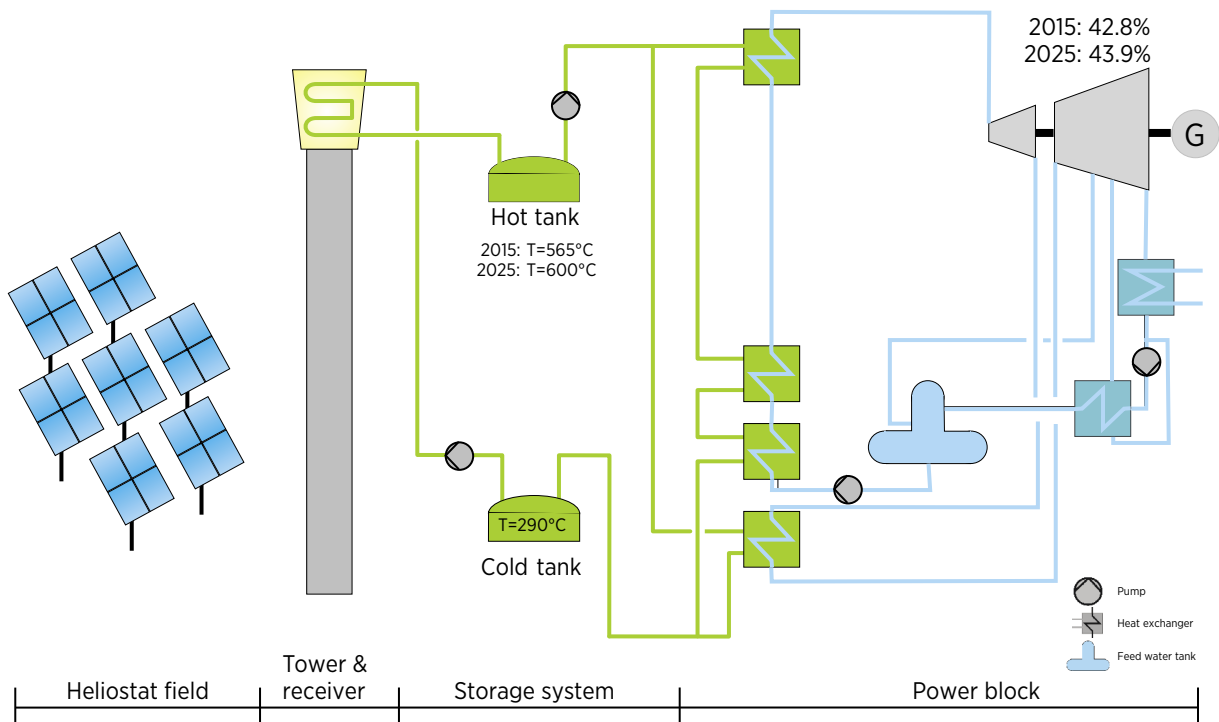
FIGURE 43: REFERENCE PARABOLIC TROUGH SYSTEM DESIGN, 2025



Source: DLR, 2016.

Note: Molten salt used as a heat transfer and storage medium (green). The water/steam circuit is also shown (blue). The letter "G" represents the generator.

FIGURE 44: REFERENCE SOLAR TOWER PLANT DESIGN, 2015 AND 2025



Source: DLR, 2016.

Note: Molten salt is used as the heat transfer fluid and storage medium (green). The water/steam circuit is also shown (blue). The letter "G" represents the generator.

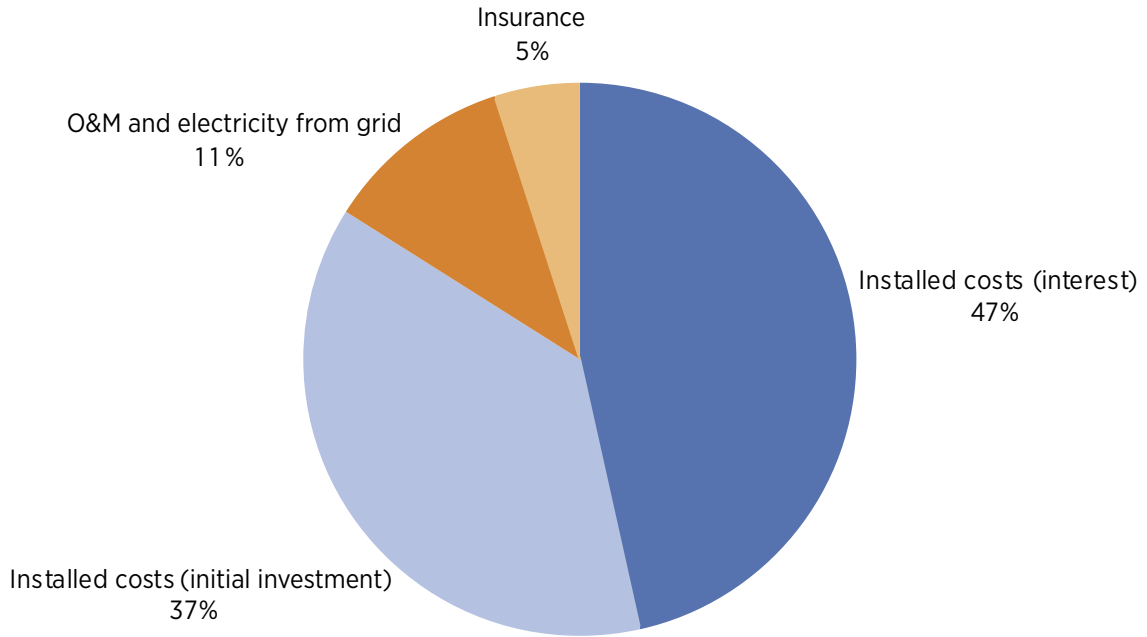
than 50%. Another technological improvement is expected to be that future PTCs will increase the aperture widths from 7.5 m to 10 m by 2025 for the trough collectors. This leads to a smaller number of collectors for the same total aperture area, reducing capital costs. These technological developments drive the expected reductions in the LCOE for CSP plants using PTCs.

The innovations expected for tower technology are less revolutionary compared to the HTF change for trough systems, since the use of solar salt for STs is already state of the art. Out to 2025, however, heliostat reflectivity and receiver efficiency are expected to improve, resulting in slightly higher operating temperatures (565-600°C) and means higher power block and overall plant efficiency levels can be achieved (Figure 44). Higher solar field and receiver efficiencies also reduce the absolute reflective area needs by 9% in the ST 2025 case, compared to the 2015 reference. This decreases investment beyond the reflective area specific costs reductions.

In terms of performance, the overall efficiency of the conversion of solar irradiation to electricity of parabolic trough plants is expected to increase from 14.9% in 2025 to 16.6% in 2025. The overall efficiency of ST technologies can be expected to increase from 15.5% in 2015 to 18.3% in 2025, driven by improved availability and higher temperature levels in combination with supercritical steam cycles (such as the ones currently used in modern coal plants).

Improving the performance of CSP plants, while also reducing installed costs, is critical to reducing the LCOE of CSP plants. Figure 45 shows the contribution to the LCOE of cost factors for the 2015 modelled PTC plant (with total investment of USD 888 million). Installed cost related items account for about 84% of LCOE (assuming the central DNI level). The results are very similar for ST plants, where installed costs account for 80% of the LCOE.

FIGURE 45: CONTRIBUTING FACTORS TO THE LCOE OF A CSP PTC SYSTEM IN 2015



Source: IRENA and DLR, 2016.

### Installed costs

The analysis of total installed costs was conducted using a detailed bottom-up techno-engineering approach. The results in this report summarise that analysis, with Table 8 showing a summary of the main cost categories and their major components for PTC and ST plants.

Indirect EPC costs comprise costs associated with engineering, management, additional EPC services,

profit margin and the contingencies of the EPC contractor.

Figure 46 shows the total installed cost breakdown of the PTC and ST reference plants modelled in 2015 and 2025. The share of total installed costs of the solar field related<sup>48</sup> items is 39% for PTC plants and 38% for ST plants in 2015. The power block share is the same in 2015 for the PTC and

<sup>48</sup> Comparing the solar field for PTCs against the heliostats of a solar field and the costs for the tower and receiver in the case of STs.

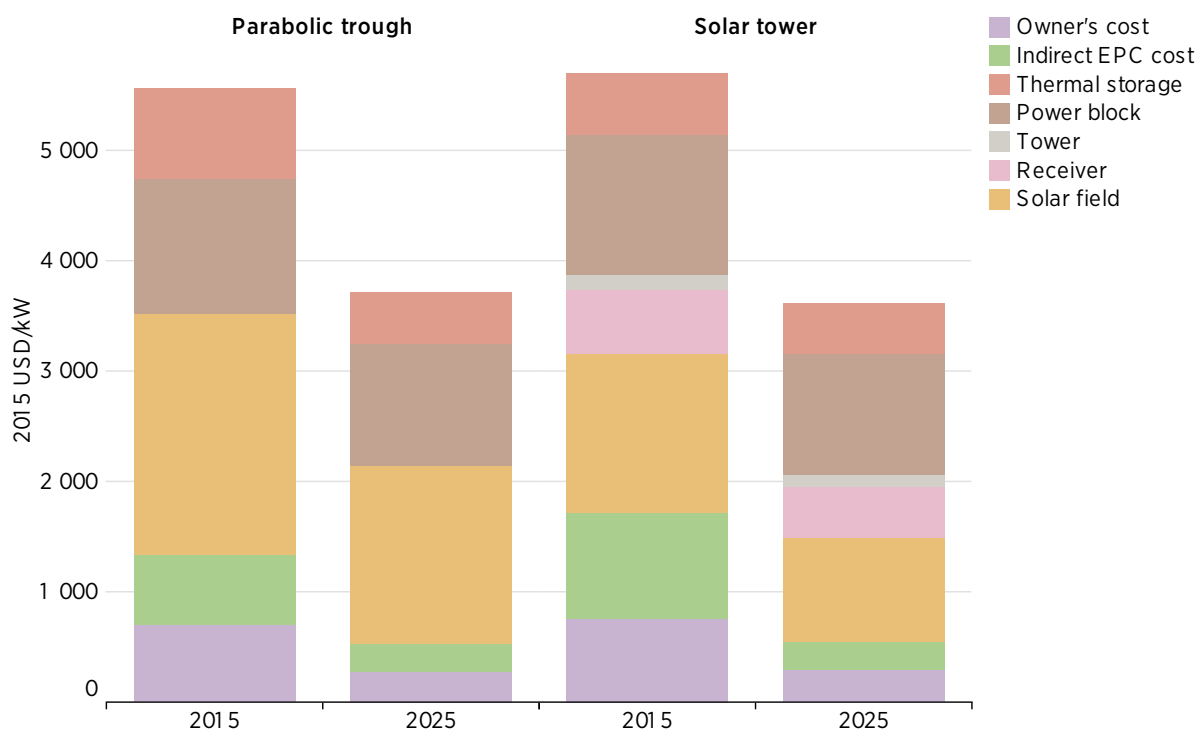
TABLE 8: TOTAL INSTALLED COST CATEGORIES AND THEIR MAJOR COMPONENTS FOR PTC AND ST PLANTS

	Parabolic trough collector	Solar tower
<b>Direct EPC</b>	Solar field Thermal storage Power block	Solar field, tower, receiver Thermal storage Power block
<b>Indirect EPC</b>	Profit margin & contingencies Other indirect EPC	
<b>Owner's costs</b>	Project development Land Infrastructure Other	

Source: IRENA and DLR, 2016.



FIGURE 46: SYSTEM COST BREAKDOWN OF CSP REFERENCE PLANTS, 2015 AND 2025



Source: IRENA and DLR, 2016.

ST plants at 22% of total. The higher share of storage costs for PTC plants (15%) compared to STs (10%) in 2015, despite the fact the ST plant has 1.5 hours more storage, is due to the fact that the higher operating temperatures (565°C for the ST compared to 393°C for the PTC plant) of the molten salt receiver of the ST more than doubles the temperature difference between the “cold” (-300°C) and the hot storage tanks. As a result, the tower system requires less than half of the storage volume for the same amount of thermal energy stored.

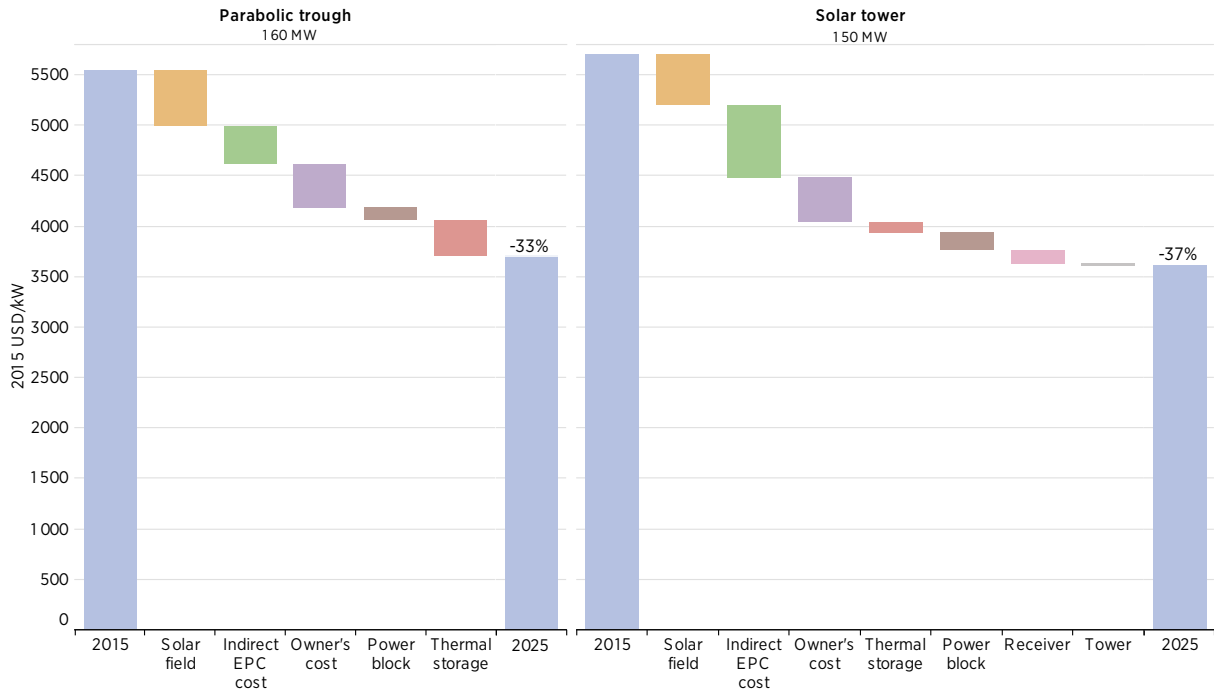
The indirect costs of towers are estimated to be significantly higher than those for trough technology in 2015 because of additional risk premiums and contingencies built into projects. The transition to molten salt for the HTF and storage medium for PTC plants is expected to reduce thermal energy storage costs by more than 40% and their share of total costs to fall from 15% in 2015 to 12% by 2025. Overall, the total installed costs for PTCs plants could decrease by one-third between 2015 and 2025.

In the case of STs, total installed costs could decline by 37% by 2025. The indirect cost reductions are expected to decrease by about three-quarters from 2015 levels. This will cause the share of indirect costs to decrease from 17% in 2015 to 7% in 2025.

Most of the installed cost reductions will be driven by technological improvements in the solar field elements and by learning effects from larger deployment volumes. Along with industry experience, these factors are expected to reduce the indirect EPC and owner's costs components (Figure 47).

PTC with 7.5 hours storage could see their total installed costs fall from USD 5 550/kW today to USD 3 700/kW in 2025. In terms of the total installed costs related to direct EPC costs, the solar field component of PTC systems is expected to contribute about half to the total direct EPC cost reduction, and one-third of the total installed cost reduction. Indirect EPC costs and owner's costs together are expected to contribute close to one-half of the total installed cost reduction potential,

FIGURE 47: PTC AND ST TOTAL INSTALLED COST REDUCTION POTENTIAL BY SOURCE, 2015-2025



Source: IRENA and DLR, 2016.

while thermal storage system cost reductions will account for about one-fifth of the overall decline in installed costs.

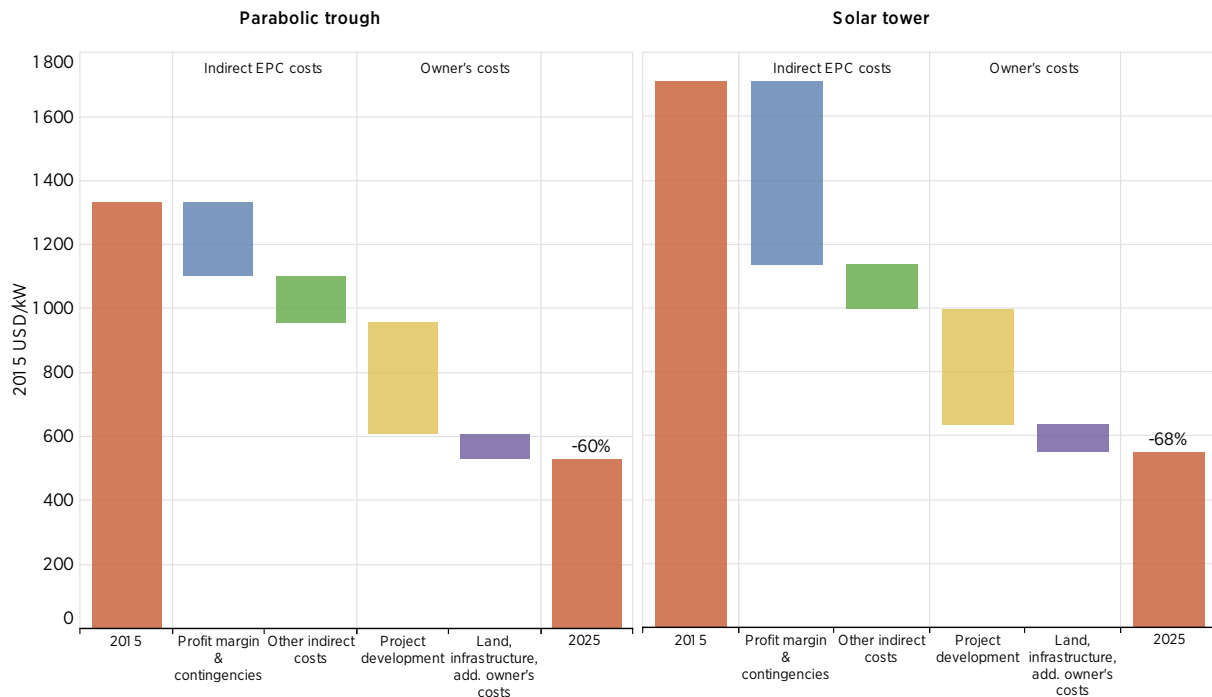
The total installed costs of ST technologies with nine hours of storage could decline from around USD 5 700 today to USD 3 600/kW by 2025. Reductions in installed costs for the solar field will account for 24% of the total reduction to 2025, indirect EPC costs for 34% and owner’s costs by 22%. Together these three categories account for 79% of the total installed cost reduction potential to 2025. This is despite the solar field (heliostats) per watt cost reduction being more moderate than in the case of PTCs. ST technologies are only just getting extensive operational experience, with many of the initial projects incurring relatively high costs for contingencies and additional surcharges. This is typical of early technology deployment, helping in part to explain the higher installed cost reduction potential for ST technology when compared to that of PTCs.

Significant indirect EPC cost declines are expected for both technologies, although these cost components for ST are, at USD 1 709/kW, around

20% higher in 2015 than for PTC plants. Indirect EPC and owner’s costs together are expected to decrease by about 60% for PTC systems and by about 68% for STs (Figure 48).

For PTCs, 29% of the installed cost reduction for indirect EPC and owner’s costs of USD 803/kW between 2015 and 2025 will come from reductions in profit margin and contingencies, 18% from other indirect costs, 43% from project development and 10% from land, infrastructure and other owner’s costs. STs, however, currently face higher contingencies, due, for example, to extended commissioning, a factor observed in some recent projects. As a result, the cost reduction opportunities for indirect EPC and owner’s costs are larger (USD 1 160/kW) and will come predominantly (49%) from reductions in profit margins and contingencies. For both technologies, owner’s costs are a significant contributor to the overall cost reduction potential out to 2025. About 80% of cost reduction potential in this respect will be linked to project development savings as developers gain more experience. For CSP systems, more efficient project development cost structures can contribute 17-19% of the overall installed cost reduction potential of the owner’s costs out to 2025.

FIGURE 48: EXPECTED INDIRECT EPC AND OWNER'S COST REDUCTIONS FOR CSP PLANTS TO 2025



Source: IRENA and DLR, 2016.

The expenditure for the solar field component of CSP plants has the potential to decrease by 23% (USD 52/m<sup>2</sup> aperture) and by 28% (USD 41/m<sup>2</sup> reflective) for PTC and ST technologies, respectively (Figure 49).<sup>49</sup> For PTC plants, the increase in aperture widths from 7.5 m to around 10 m over the period to 2025 will yield higher concentration factors and offer savings from the reduced number of collectors required for the same aperture area. This development will also cause investment cost cuts for several related cost components, such as foundations, receivers and pylons.

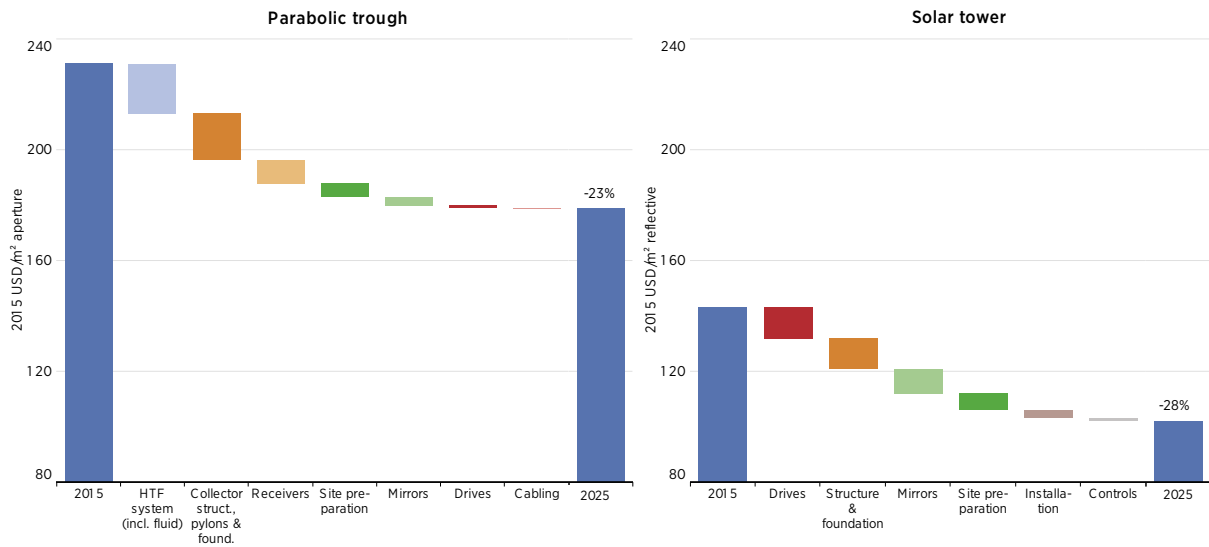
For PTC plants, the combination of larger aperture widths and the differences in fluid properties of molten salt compared to thermal oil means that about 40% less HTF is required. The combined impact is that the aperture area specific costs for the HTF system (including the fluid) are expected to decrease by about 31% from 2015-25. The net effect of these factors is that the per aperture area cost reductions in the HTF system (including the fluid) will account for 34% of the total solar field cost reduction potential. While the savings

in collector structure, pylons and foundations will contribute another 33%. Cost reduction in receivers then contributes about 15% of the total potential reduction (Figure 49).

For the receiver tubes that convert the concentrated sun rays into thermal energy, the trend towards higher operating temperatures could trigger technical improvements for some receiver elements, such as the absorber coating on the receiver. These improvements could reduce length-specific heat losses by 20%, improving performance. At the same time, the use of larger collectors will cause the specific costs per aperture area for receivers to drop by about 25%. The combination of these developments is expected to result in a 30% cost decline per aperture square metre for receivers by 2025. Using the same molten salt fluid in the solar field and in the storage system simplifies the design of the HTF system and means that heat exchangers between the thermal oil and molten salt storage are no longer needed. The cost saving from not having these heat exchangers, has no impact on total installed costs, however, as additional costs for

<sup>49</sup> These metrics are not directly comparable, as costs are per aperture area for PTCs and cost per reflective area for STs.

FIGURE 49: COST REDUCTION POTENTIALS OF THE SOLAR FIELD COMPONENT OF PTC AND ST CSP PLANTS BY SOURCE, 2015-2025



Source: IRENA and DLR, 2016.

antifreeze measures<sup>50</sup> in the solar field more or less offset the savings on the heat exchangers.

Total solar field cost reductions for STs of USD 41/m<sup>2</sup> reflective could contribute about one-quarter to the overall CAPEX reduction potential out to 2025. This is about 5% lower than for PTCs. For ST technologies, the majority of cost reductions in the solar field (heliostats) will be driven by cost per reflective area reductions in drives, which are expected to account for 28% of the total solar field reduction potential based on cost declines per reflective area of around one-quarter. Some of the cost improvements could come from the replacement of costly slewing drives with linear drives with limited angular flexibility, or with alternative drive concepts.<sup>51</sup> In addition to lower costs, improved controls for the drives and focusing systems could result in greater focusing accuracy and increased performance, while improved maintenance programmes can reduce downtime.

Structural and foundation design improvements are expected to reduce costs. Increased standardisation and more highly automated assembly procedures – perhaps with increased

pre-assembly – will account for around 26% of the total cost reductions per reflective area for ST solar fields by 2025. Additionally, as the market for ST grows, higher market volumes will push down costs for flat mirrors. Due to low market volumes, the flat mirrors used in ST are slightly more expensive than the concave mirrors used in PTCs, even though concave mirrors are more costly to manufacture. This relationship is expected to reverse by 2025, however, allowing mirrors to contribute another 23% of the total solar field reduction potential for ST.

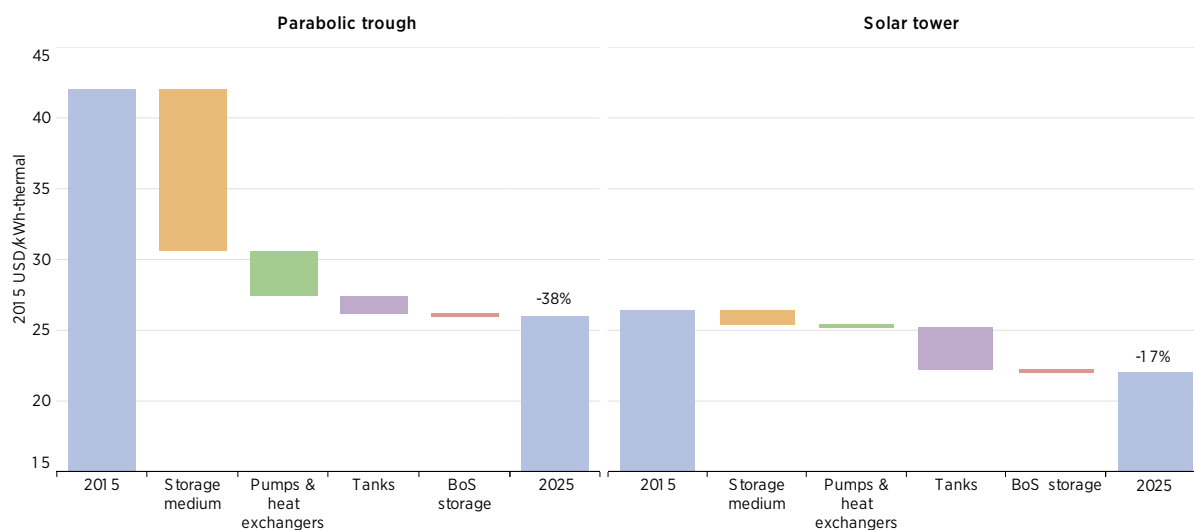
At the same time, manufacturing improvements will yield small performance gains related to higher accuracy. In order to take advantage of the higher reflectivity of thin glass mirrors, so-called “sandwich” facet solutions are also being explored. These consist of a thin glass mirror as a front layer, a standard foam core and a steel back layer. These solutions may also contribute to the mirrors’ cost reduction potential. Sandwich facet solutions have the additional advantages of lower weight (reducing foundation and support structure costs), higher hail resistance and less mirror breakage.<sup>52</sup>

<sup>50</sup> Freezing temperature of solar salt assumed at 140°C.

<sup>51</sup> This could be facilitated by lower accuracy requirements from the drive if the optical sensors are improved.

<sup>52</sup> See Pfahl, *et al.*, 2012 for a discussion of these issues.

FIGURE 50: THERMAL ENERGY STORAGE COST REDUCTION POTENTIALS FOR PTC AND ST SYSTEMS BY SOURCE, 2015-2025



Source: IRENA and DLR, 2016.

## Thermal storage costs

By 2025, the per kilowatt hour of thermal energy installed costs for the storage systems of CSP plants could decrease by about 38% for PTCs and by about 17% for STs (Figure 50). The large difference between the storage costs of PTC and ST technologies in 2015 is due to the higher operating temperature of the ST plant using molten salt as the HTF compared to the PTC plant that is using thermal oil as a HTF (since the use of thermal oil limits the HTF temperature to below 400°C due to decomposition issues).

In contrast, the transition to the use of molten salt as a HTF in PTC plants means that a much higher cost reduction potential exists for PTC plants. By 2025, the use of molten salt as the HTF will raise operating temperatures and allow the storage medium requirements to be decreased by around half while maintaining the same number of hours of operation.<sup>53</sup> As a result, the installed costs of the storage medium (per kWh-thermal) for a PTC system using molten salt as an HTF are around 50% lower compared to the 2015 reference. The reduced storage medium costs account for 71% of the total reduction in thermal energy storage installed costs of USD 16/kWh-thermal between

<sup>53</sup> Storage hours are assumed at 7.5 for PTC technologies in both 2015 and 2025.

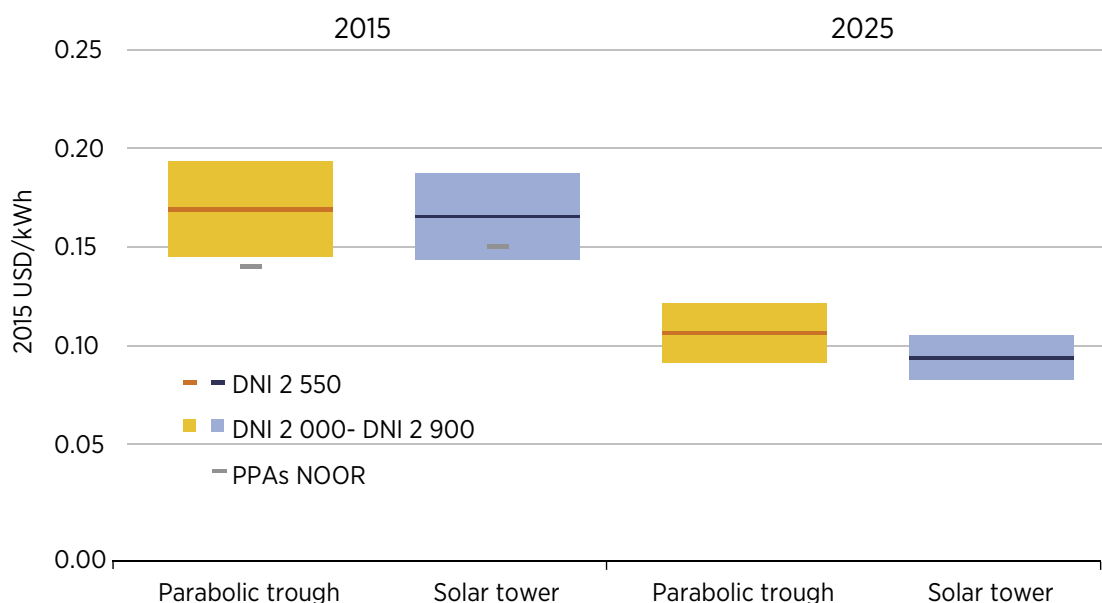
2015 and 2025. Given that ST technologies already operate at higher temperatures than today's PTC plants using thermal oil as an HTF, the cost reduction potential for ST plants from the heat storage medium is modest, with most of the cost reduction coming from reduced costs for the storage tanks themselves. This is driven by the small maximum HTF temperature increase for ST plants to 2025 (from 565°C to 600°C).

The contribution of thermal energy storage system cost reductions to the total reduction in installed costs is around 20% for PTC systems, but a more modest 5% for ST plants given they already use today's state of the art solution.

## LCOE DEVELOPMENT TO 2025

By 2025, the LCOE of CSP technologies could decrease by 37% (USD 0.06/kWh) for PTCs and by 43% (USD 0.07/kWh) for STs based on the technology and cost drivers discussed in this chapter. The decrease in the LCOE out to 2025 will be heavily driven by capital investment cost reductions. For PTC plants, 68% of the total LCOE reduction potential to 2025 can be attributed to the reduction in installed costs, while for ST plants the figure is 61%.

FIGURE 51: THE LEVELISED COST OF ELECTRICITY OF PTC AND ST TECHNOLOGIES, 2015 AND 2025



Source: IRENA and DLR, 2016.

In 2015, both trough and tower technologies were in the same LCOE range of about USD 0.15 to USD 0.19/kWh, with PTC plants having a reference value of USD 0.165/kWh and ST plants USD 0.161/kWh (the red and blue lines in Figure 51). By 2025, the LCOE range could decline to USD 0.09 to USD 0.12/kWh for troughs and USD 0.08 to USD 0.11/kWh for towers, with reference values of USD 0.104/kWh and USD 0.091/kWh respectively in 2025 (Figure 51). The LCOE ranges (the shaded areas in Figure 51) for each technology in both years are calculated based on varying DNI, but holding the other main assumptions fixed.

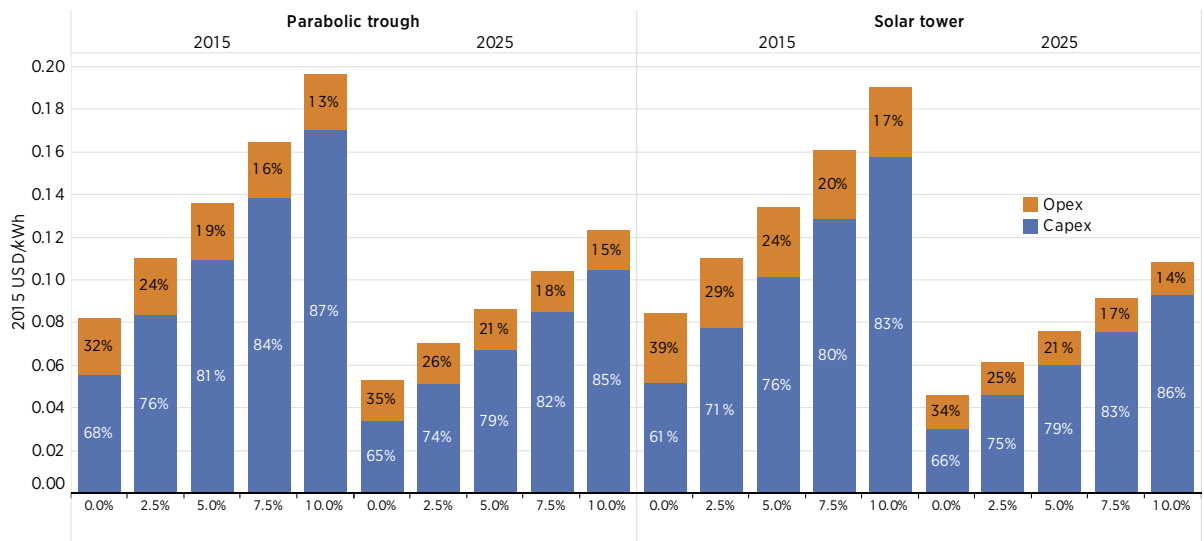
Figure 51 also includes the PPA values from the Noor II and Noor III projects in Morocco.<sup>54</sup> The more favourable financing conditions accessed by these projects explains the variation from the reference value LCOEs. Figure 52 shows the sensitivity of the LCOE to changes in WACC. For example, at a more favourable WACC of 5%, compared to the assumption of 7.5%, the current LCOE of trough and tower plants would fall to just below

<sup>54</sup> The apparent mismatch between the PPAs and the modelled LCOEs is corrected when the financing conditions are adapted to values more likely for the NOOR projects. Even though the financing conditions are not publicly available, it is probable that the WACC is much lower than 7.5%.

USD 0.14/kWh for the central DNI scenario and would be as low as USD 0.12/kWh at higher DNI sites. By 2025 the LCOE of CSP plants at 5% WACC could be as low as USD 0.09/kWh for PTC and USD 0.08/kWh for ST. Figure 52 also highlights the growing share of O&M costs as installed costs decline and the performance of both PTC and ST plants improves.

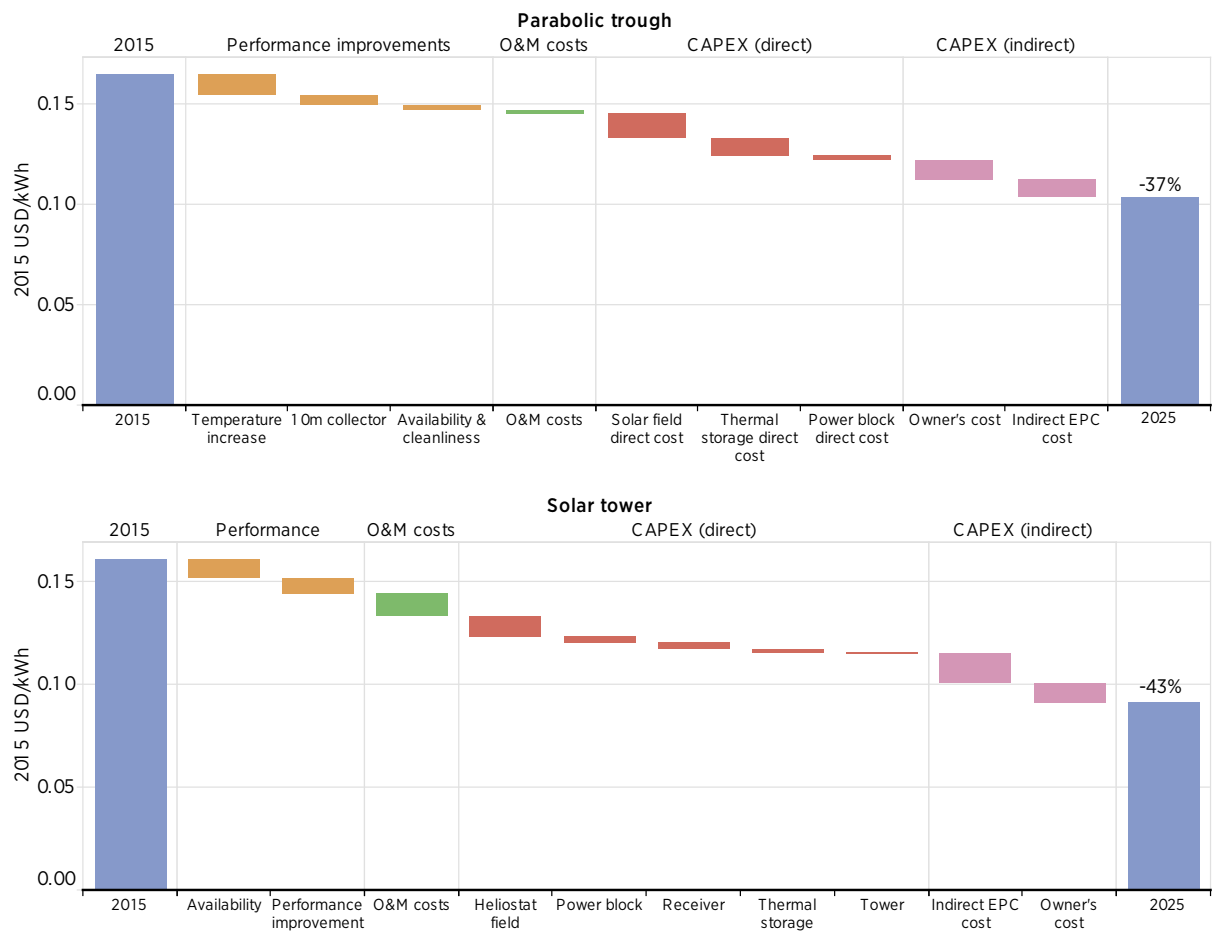
Figure 53 shows a summary of the cost reduction drivers and their relative contributions to the reduction potential for PTC and ST plants. In the central DNI case, the expected increase in electricity output for 2015-25 is 8.4% for PTCs and 7.6% for STs. For PTC and STs, performance improvements that result in higher electricity outputs account for 30% and 25% of the total LCOE reduction potential, respectively. O&M costs have a more significant impact for ST than for PTC systems, contributing about 15% of the potential LCOE reduction, compared to just 2% for PTC systems. Direct CAPEX contributes 38% and 27% to the LCOE reduction potential for PTC and ST, respectively. Installed cost reductions for the solar field of PTC plants contribute 21% of the total LCOE reduction potential to 2025. For ST systems, cost reductions in the heliostats account for 14% of the

FIGURE 52: SENSITIVITY OF THE LEVELISED COST OF ELECTRICITY OF PTC AND ST PLANTS TO VARIATIONS IN THE WACC, 2015 AND 2025



Source: IRENA and DLR, 2016.

FIGURE 53: THE LEVELISED COST OF ELECTRICITY REDUCTION POTENTIAL FOR PTC AND ST PLANTS BY SOURCE, 2015-2025



Source: IRENA and DLR, 2016.

total LCOE reduction. In terms of indirect CAPEX costs, the respective contributions are 30% and 34% for PTC and ST plants.

For PTCs, two major cost drivers can be identified. The first is an increase in the temperature level enabled by the switchover to molten salt as the HTF, with consequent lower investment costs for thermal storage, due to a size reduction of more than 50%. This accounts for about 13% of the total LCOE reduction. The second important cost driver is the reduction of solar field costs, which accounts for around one-fifth of the total LCOE reduction to 2025. This is closely related to the usage of a trough collector with a wider aperture, which means fewer collector units are needed. Together, both factors lead to LCOE reductions of USD 0.021/kWh (34% of the reduction potential).

For STs, the largest single driver for LCOE reductions is related to gains in the EPC experience. The indirect EPC cost alone is expected to contribute about one-fifth to the overall LCOE reduction potential of towers. Since many of the EPC contractors and project developers built their first tower projects in 2015, risk margins are still high. In addition, the commissioning phase is extended and in the first years of operation, the operational costs are higher compared to mature trough technology. These early teething problems also impact availability. For STs, this availability is assumed at 93% in 2015, while for PTCs, it is assumed at 98%. Both technologies are assumed to achieve availabilities of 99% by 2025. Such assumptions account for longer outages due to unscheduled additional maintenance and the replacement of broken components, which could be seen at several of the tower projects built up to now. As a result, O&M costs also decline to 2025 for ST plants and they account for 15% of the total reduction in LCOE to 2025.



# ABBREVIATIONS

°C	Degree Celsius
AC	Alternating current
ACC	Air-cooled condenser
a-Si	Amorphous silicon
a-Si/ $\mu$ c-Si	Micromorph silicon
BNEF	Bloomberg New Energy Finance
BoS	Balance of system
CAPEX	Capital expenditure
CdS	Cadmium sulfide
CdTe	Cadmium-Telluride
CIGS	Copper-Indium-Gallium-Diselenide
CIS	Copper-Indium-Selenide
CO <sub>2</sub>	Carbon dioxide
CPV	Concentrating photovoltaic
c-Si	Crystalline silicon
CSP	Concentrating solar power
DC	Direct current
DLR	Deutsches Zentrum für Luft- und Raumfahrt (German Aerospace Center)
DNI	Direct normal irradiance
DPO	Diphenyl oxide
EMEA	Europe, the Middle East and Africa
FACTS	Flexible AC transmission systems
FiT	Feed-in tariff
GW	Gigawatt
h	Hour
HTF	Heat transfer fluid
IBC	Interdigitated back-contact cells
IEA	International Energy Agency
IEA PVPS	IEA Photovoltaic Power Systems Programme
ILR	Inverter load ratio
IPP	Independent power producer
ITC	Investment tax credit
km	Kilometre
KNO <sub>3</sub>	Potassium nitrate
kV	Kilovolt
kW	Kilowatt
kWh	Kilowatt hour
LBNL	Lawrence Berkeley National Laboratory
LCOE	Levelised cost of electricity

M	Metre
m/s	metres per second
MENA	Middle East and North Africa region
MLPE	Module-level power electronics
MW	Megawatt
NaNO <sub>3</sub>	Sodium nitrate
NASA	National Aeronautics and Space Administration
NREL	National Renewable Energy Laboratory
O&M	Operations and maintenance
OECD	Organisation for Economic Co-operation and Development
OPEX	Operations expenditure
PERC	Passivated emitter rear cell
PPA	Power purchase agreement
PTC	Parabolic trough collectors
PV	Photovoltaic
ST	Solar tower
US	United States of America
USD	United States dollars
V	Volt
W	Watt
WACC	Weighted average cost of capital
μc-Si	Microcrystalline silicon

# REFERENCES

- Angelopoulos, D., *et al.* (2016). Risks and cost of capital for onshore wind energy investments in EU countries. *Energy & Environment*, 27(1), 82-104.
- Birnbaum, J., Eck, M., Fichtner, M., Hirsch, T., Lehmann, D. and Zimmermann, G. (2010). "A Direct Steam Generation Solar Power Plant with Integrated Thermal Storage." Las Vegas, USA: ASME. *J. Sol. Energy Eng.*
- BNEF. (2014). *Renewable Power Projects Database*. London: Bloomberg New Energy Finance.
- BNEF. (2016a). *Wind Turbine Price Index*. London: Bloomberg New Energy Finance.
- BNEF. (2016b). *Wind Turbine Maintenance Price Index*. London: Bloomberg New Energy Finance.
- BNEF. (2016c). *BNEF Global Wind Turbine Market Share*. London: Bloomberg New Energy Finance.
- BVG Associates. (2012). *Offshore Wind Cost Reduction Pathways Technology Work Stream*. London: Crown Estate.
- CanWEA. (2016). *Canadian Wind Farm Database*. Canadian Wind Energy Association.
- Cohen, G. E. (1999). *Final Report on the Operation and Maintenance Improvement Program for Concentrating Solar Power Plants, SAND99-1290*. NM.: Sandia National Laboratories.
- CREARA. (2016). *Solar PV Module & Inverter Cost Reduction Potential to 2025*.
- DEA. (2016). *Wind Farm Database*. Danish Energy Agency.
- deea. (2016). *Report on Solar PV Balance of System Cost Reduction Potential to 2025*.
- Deutsche WindGuard. (2013). *Kostensituation der Windenergie an Land in Deutschland*. Varel: Deutsche WindGuard.
- DLR (German Aerospace Center). (2016). *Assessment of the Cost Reduction Potential for Concentrating Solar Power until 2025*. Deutsches Zentrum für Luft- und Raumfahrt (German Aerospace Center).
- Douglas-Westwood. (2010). *Offshore Wind Assessment in Norway*. Oslo: The Research Council of Norway.
- European Solar Thermal Electricity Association (Estela), Greenpeace International, SolarPACES. (2016). *Solar Thermal Electricity Global Outlook 2016*. Estela, Greenpeace International, SolarPACES.
- EWEA. (2009). *The Economics of Wind Energy*. Brussels: European Wind Energy Association.
- EWEA. (2016). *The European Offshore Wind Industry – Key Trends and Statistics 2015*. Brussels: European Wind Energy Association.
- Fichtner. (2010). *Technology Assessment of CSP Technologies for a Site Specific Project in South Africa. Final Report*. Washington D.C.: The World Bank and ESMAP.

First Solar. (2016a). First Solar Q4 2015 Earnings Call. Retrieved from [http://files.shareholder.com/downloads/FSLR/2011520970x0x876839/CB2B4E18-514A-4242-AC3E-CFE2D42D6FEB/Q415\\_Earnings\\_Call\\_Presentation\\_-\\_Final.pdf](http://files.shareholder.com/downloads/FSLR/2011520970x0x876839/CB2B4E18-514A-4242-AC3E-CFE2D42D6FEB/Q415_Earnings_Call_Presentation_-_Final.pdf)

First Solar. (2016b). April 5, 2016 Analyst meeting. Manufacturing update. Retrieved from <http://investor.firstsolar.com/eventdetail.cfm?eventid=170962>

Fraunhofer ISE. (2015). *Current and Future Cost of Photovoltaics. Long-term Scenarios for Market Development, System Prices and LCOE of Utility-Scale PV Systems*. Study on behalf of Agora Energiewende.

Fraunhofer ISE. (2016). *Photovoltaics Report*. Freiburg: Fraunhofer Institute for Solar Energy.

Friedman, B., Margolis, R. and Seel, A. J. (2014). *Comparing Photovoltaic (PV) Costs and Deployment Drivers in the Japanese and U.S. Residential and Commercial Markets*. National Renewable Energy Laboratory.

Fu, R., James, T. L., Chung, D., Gagne, D., Lopez, A. and Dobos, A. (2015). *Economic Competitiveness of U.S. Utility-Scale Photovoltaics Systems in 2015: Regional Cost Modeling of Installed Cost (\$/W) and LCOE (\$/kWh)*. New Orleans, LA: Photovoltaic Specialist Conference (PVSC), 2015 IEEE 42nd.

GlobalData. (2014). *Power Generation Technologies Capacities, Generation and Markets Database*. London: GlobalData.

GlobalData. (2015). *Solar PV Inverter Market, Update 2015 – Segmentation, Market Size, Competitive Landscape, and Analysis to 2020*. London: GlobalData.

GlobalData. (2016). *Wind Project Database*. London: GlobalData Ltd.

GTM Research. (2015). *The Global PV Inverter Landscape 2015: Technologies, Markets and Prices*. GTM Research.

Hirth, L., & Müller, S. (2016). "System-Friendly Wind Power: How Advanced Wind Turbine Design Can Increase the Economic Value of Electricity Generated through Wind Power." *Energy Economics*, Vol. 56.

Hoffman, W. (2014). *The Economic Competitiveness of Renewable Energy: Pathways to 100% Global Coverage*. Beverly, MA: Scrivener Publishing.

IEA Wind. (2011). Task26: Multi-national Case Study of the Financial Cost of Wind Energy. Work Package 1. Final Report. IEA Wind Energy Systems.

IEA Wind. (2015). Task 26: Wind Technology, Cost, and Performance Trends in Denmark, Germany, Ireland, Norway, the European Union, and the United States: 2007 - 2012. IEA Wind Energy Systems.

IHS. (2015). *PV Balance of System Equipment Report*. Englewood, Colorado: IHS.

IRENA. (2012). *Renewable Energy Technologies Cost Analysis Series: Wind Power*. Abu Dhabi: International Renewable Energy Agency.

IRENA. (2015). *Renewable Power Generation Costs in 2014*. Abu Dhabi: International Renewable Energy Agency.

IRENA. (2016a). *REmap: Roadmap for a Renewable Energy Future*. Abu Dhabi: International Renewable Energy Agency.

IRENA. (2016b). *Innovation Outlook for Offshore Wind Technology*. Abu Dhabi: International Renewable Energy Agency.

IRENA. (2016c). *Renewable Capacity Statistics 2016*. Abu Dhabi: International Renewable Energy Agency.

Kersten, F., Doll, R., Kux, A., Huljić, D. M., Görig, M. A., Breyer, C., . . . Wawer, P. (2011). *PV Learning Curves: Past and Future Drivers of Cost Reduction*. Hamburg, Germany: 26th European Photovoltaic Solar Energy Conference.

KIC InnoEnergy. (2014a). Future renewable energy costs: onshore wind. How technology innovation is anticipated to reduce the cost of energy from European onshore wind farms. Eindhoven, The Netherlands: KIC InnoEnergy.

KIC InnoEnergy. (2014b). Future renewable energy costs: offshore wind. How technology innovation is anticipated to reduce the cost of energy from European offshore wind farms. Eindhoven, The Netherlands: KIC InnoEnergy.

KIC InnoEnergy. (2016). Future renewable energy costs: solar photovoltaics. How technology innovation is anticipated to reduce the cost of energy from European photovoltaic installations. Eindhoven, The Netherlands: KIC InnoEnergy.

Lawrence Berkeley National Laboratory (LBNL). (2014). *Utility-Scale Solar 2013. An Empirical Analysis of Project Cost, Performance, and Pricing Trends in the United States*. CA: LBNL.

LBNL. (2015a). *Is \$50/MWh Solar for Real? Falling Project Prices and Rising Capacity Factors Drive Utility-Scale PV Toward Economic Competitiveness*. CA: LBNL.

LBNL. (2015b). *Utility-Scale Solar 2014. An Empirical Analysis of Project Cost, Performance, and Pricing Trends in the United States*. CA: LBNL.

MAKE Consulting. (2011). *Wind Turbine Trends Balancing Technology & Costs to Secure Profitable Growth*. Aarhus, Denmark: MAKE Consulting.

MAKE Consulting. (2015a). *Global Wind Turbine Trends*. Aarhus, Denmark: MAKE Consulting.

MAKE Consulting. (2015b). *Wind Energy Levelised Cost of Electricity (LCOE): Globally Competitive*. Aarhus, Denmark: MAKE Consulting.

MAKE Consulting. (2016a). *Q1 Global Wind Power Market Update*. Aarhus, Denmark: MAKE Consulting.

MAKE Consulting. (2016b). *2016 Service Market Survey*. Aarhus, Denmark: MAKE Consulting.

Manwell, J. F., McGowan, J. G., & Rogers, A. L. (2010). *Wind energy explained: theory, design and application*. Chicago: John Wiley & Sons.

NREL, S. (2014). *Concentrating Solar Power Projects Database*. <http://www.nrel.gov/csp/solarpaces/>: NREL.

Pfahl, A., Randt, M., Kubisch, S., Holze, C. and Brüggem, H. (2012). *Autonomous Light-Weight Heliostat with Rim Drives*. Marrakech, Morocco: International Conference on Concentrating Solar Power and Chemical Energy Systems SolarPaces 2012.

Photon Consulting. (2016). *Data from Photon Consulting's Demand Subscription*. USA: Photon Consulting.

Public Utilities Commission of Nevada. (2015). Application of Nevada Power Company. Reference: 18f540af-0d52-461b-823e-b3b542b676ee. Filed for NPC on 7/1/2015 1:50:12 pm. Nevada: Public Utilities Commission of Nevada.

pvXchange. (2016). *Solar PV Price Index*. pvXchange GmbH.

Seel, J. and Wiser, G. B. (2014). *An Analysis of Residential PV System Price Differences between the United States and Germany*. CA: Lawrence Berkeley National Laboratory.

SEMI. (2016). *International Technology Roadmap for Photovoltaic (ITRPV)*. Seventh Edition, 2016. Version 2. SEMI.

Serrano-González, J., & Lacal-Aránategui, R. (2016). Technological evolution of onshore wind turbines—a market-based analysis. Petten, the Netherlands: European Commission, Joint Research Centre, Institute for Energy and Transport.

Siemens. (2015). *Siemens Energy Management Press Releases 2015*. Retrieved May 2016, from “New AC Grid Access Solution from Siemens: Lighter, faster, cheaper”: <http://www.siemens.com/press/en/pressrelease/?press=/en/pressrelease/2015/energymanagement/pr2015030151emen.htm&content%5b%5d=EM>

STA. (2014). *Cost Reduction Potential of Large Scale Solar PV*. London: Solar Trade Association.

Theologitis, I.-T. and Masson, G. (2015). *Potential for Cost Reduction of PV Technology – Impact of CHEETAH Research Innovations*.

Turchi, E. A. (2010a). *Current and Future Costs for Parabolic Trough and Power Tower Systems in the US Market*. Boulder, CO.: NREL.

Turchi, E. A. (2010b). *Parabolic Trough Reference Plant for Cost Modeling with the Solar Advisor Model*. Boulder, CO: NREL.

Vartiainen, E., Masson, G. and Breyer, C. (2015). *PV LCOE in Europe 2014-30*. European PV Technology Platform Steering Committee. PV LCOE Working Group.

Villegas Nuñez, J. (2013). “Multilevel Topologies: Can New Inverters Improve Solar Farm Output?” *Solar Industry Magazine*. [http://solarindustrymag.com/online/issues/SI1301/FEAT\\_05\\_Multilevel%20Topologies.html](http://solarindustrymag.com/online/issues/SI1301/FEAT_05_Multilevel%20Topologies.html).





[www.irena.org](http://www.irena.org)

Copyright © IRENA 2016